

Válido de 09/01/2023 a 30/04/2023

Promoções válidas para stock existente

Edição 2023.1.V2

05.04.2023

TABELA BOSCH

1º Quadrimestre 2023

DE PROFISSIONAIS > PARA PROFISSIONAIS



MÁXIMA VERSATILIDADE PARA QUALQUER TIPO DE PARAFUSO.

Novas aparafusadoras de impacto GDS 18V-450HC com conectividade.

Rendimento potente de 450 Nm de binário de aperto. Encaixe de 1/2".
Dois modos pré determinados de trabalho (madeira e metal) e três ajustes de velocidade versáteis, para maior flexibilidade e controlo.



LOTE MÁQUINAS A BATERIA



KIT 12V (5 Ferramentas)

0615990N1D

- 1 Berbequim/Aparafusadora GSR 12V-15
- 1 Aparafusadora Impacto GDR 12V-105
- 1 Serra de Sabre GSA 12V-14
- 1 Multi - Ferramenta GOP 12V-28
- 1 Lanterna (Power Led) GLI 12V-80
- 3 Bat. Lítio 12V de 2,0Ah
- 1 Carregador
- 1 Lâmina Serra S522EF
- 1 Lâmina Serra S511DF
- 1 Prato Lixar Delta 85mm
- 5 Folhas Lixa
- 1 L-Boxx 238

479,00 €



KIT MONTAGEM 1 (COMBO KIT)
(2 Ferramentas + 2 Baterias)

0615990M0R

- 1 Martelo Elétrico Pneumático GBH 18V-21
- 1 Berbequim aparafusadora GSR 18V-28
- 2 Bat. Lítio 18V de 4,0Ah
- 1 Carregador GAL 18V-40
- 2 L-Boxx 136

457,00 €



KIT MONTAGEM 2 (COMBO KIT)
(2 Ferramentas + 2 Baterias)

0615990M0P

- 1 Martelo Elétrico Pneumático GBH 18V-21
- 1 Berbequim/Aparafusadora GSR 18V-21
- 2 Bat. Lítio 18V de 4,0Ah+1Bat 2,0Ah
- 1 Carregador GAL 1880 CV
- 25 Acessórios
- 1 Saco Medium

387,00 €



KIT MONTAGEM 3 (COMBO KIT)
(2 Ferramentas + 2 Baterias)

0615990M4A

- 1 Berbequim c/percussão GSB 18V-55
- 1 Rebarbadora GWS 18V-7(115)
- 2 Baterias 18V 4,0Ah
- 1 Carregador GAL 18V-40
- 1 Saco Medium

382,00 €



KIT INSTALADOR 1
(3 Ferramentas+3 Baterias)

0615990N2A

- 1 Martelo Eléctrico Pneumático GBH 18V-26F
- 1 Berbequim/Aparafusadora GSR 18V-110C
- 1 Rebarbadora GWS 18V-10P
- 3 Bat. 18V ProCORE. [2x4,0Ah + 1x8,0Ah]
- 1 Carregador GAL 18-160C
- 1 L-BOXX 374 (XL)

899,00 €



KIT INSTALADOR 2
(3 Ferramentas+3 Baterias)

0615990N29

- 1 Martelo Eléctrico Pneumático GBH 18V-21
- 1 Berbequim C/Percussão GSB 18V-45
- 1 Rebarbadora GWS 18V-10 (125)
- 3 Bat. 18V [2x5,0Ah + 1x5,5Ah ProCORE]
- 1 Carregador GAL 18-40 CV
- 1 Saco Medium

744,00 €



KIT INSTALADOR 3
(3 Ferramentas+3 Baterias)

0615990M3C

- 1 Martelo Eléctrico Pneumático GBH 18V-26
- 1 Berbequim/Aparafusadora GSR 18V-28
- 1 Rebarbadora GWS 18V-10 (125)
- 2 Bat. 18V ProCORE. [1x4,0Ah + 1x8,0Ah]
- 1 Carregador GAL 1880 CV
- 1 Saco Medium

744,00 €



KIT INSTALADOR 4
(3 Ferramentas+3 Baterias)

LOTE BOSCH 1260

- 1 Martelo Eléctrico Pneumático GBH 18V-21
- 1 Berbequim percussão GSB 18V-55
- 1 Rebarbadora GWS 18V-7 (115)
- 3 Bat. Lítio 18V de 4,0Ah
- 1 Carregador
- 1 Saco Medium

679,00 €

BERBEQUINS COM PERCUSSÃO



GSB 12V-15
Mala L-BOXX
06019B690E
113,00 €
Caixa de cartão
06019B6901
97,00 €



GSB 12V-35
Mala L-BOXX
06019J9001
146,00 €
Caixa de cartão
06019J9002
131,00 €

APARAFUSADORAS



GSR 12V-15
Mala L-BOXX
060186810D
107,00 €
Caixa de cartão
0601868101
84,00 €



SISTEMA FLEXICLIC
GSR 12V-15 FC
Caixa de cartão
06019F6004
125,00 €



APARAFUSADORAS



SISTEMA FLEXICLIC
GSR 12V-35 FC
Mala L-BOXX
06019H3003
240,00 €
Full Set: 4 Accesorios

APARAFUSADORAS / CHAVES DE IMPACTO



GDR 12V-105
Mala L-BOXX
06019A6906
149,00 €
Caixa de cartão
06019A6901
128,00 €
1/4"



GDR 12V-110
Mala L-BOXX
06019E0003
177,00 €
Caixa de cartão
06019E0002
156,00 €
1/4"



GDS 12V-115
Mala L-BOXX
06019E0102
173,00 €
Caixa de cartão
06019E0101
154,00 €
3/8"

MINI TUPIA



GKF 12V-8
Mala L-BOXX
06016B0001
226,00 €
Caixa de cartão
06016B0002
188,00 €

LANTERNAS



GLI 12V-300
Caixa de cartão
06014A1000
51,00 €



GLI 12V-330
Caixa de cartão
06014A0000
76,00 €



GLI Variled
Funda de transporte
0601443400
76,00 €

MULTI-CORTADOR



GUS 12V-300
Mala L-BOXX
06019B2905
156,00 €
Caixa de cartão
06019B2901
135,00 €

MULTI-FERRAMENTA



GOP 12V-28
Mala L-BOXX
06018B5002
156,00 €
Caixa de cartão
06018B5001
135,00 €

BERBEQUIM ANGULAR



GWB 12V-10
Mala L-BOXX
0601390909
146,00 €

REBARBADOR

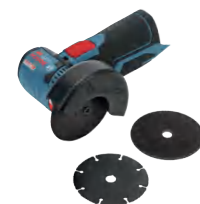

CÂMARA TÉRMICA



GTC 400 C
Mala L-BOXX
0601083108
1 249,50 €

NÍVEL LASER



GLL 3-80 CG
Mala L-BOXX
0601063T03
753,00 €

BATERIAS, CARREGADORES

BATERIAS



GBA 12V 2,0 Ah
1600Z0002X
48,00 €



GBA 12V 6,0 Ah
1600A00X7H
84,00 €



GBA 12V 3,0 Ah
1600A00X79
58,00 €

CARREGADORES

SÓ O QUE NECESSITAS



Se já tens baterias e carregadores, compra as ferramentas que necessitas de forma individual para ampliar o teu equipamento de trabalho.

Necessitas de mais baterias e carregadores?



FERRAMENTAS SEM Baterias nem Carregadores



GSR 12V-15 FC

Mala L-BOXX
06019F6002
146,00 €

Portabrocas



GSR 12V-35

Mala L-BOXX
06019H8001
142,00 €

Caixa de cartão
06019H8000
121,00 €



GSR 12V-35 HX

Mala L-BOXX
06019J9102
144,00 €

Caixa de cartão
06019J9103
131,00 €

Inserción hexagonal



GSR 12V-35 FC

Caixa de cartão
06019H3004
131,00 €



GSR 12V-35 FC

Mala L-BOXX
06019H3002
173,00 €

Portabrocas



APARAFUSADOR PARA GESSO CARTONADO



GTB 12V-11

Mala L-BOXX
06019E4003
156,00 €

Caixa de cartão
06019E4002
135,00 €

LIXADORA EXCÊNTRICA



GEX 12V-125

Mala L-BOXX
0601372100
167,00 €

Caixa de cartão
0601372101
146,00 €

LIXADORA ORBITAL



NOVIDADE

GSS 12V-13

Mala L-BOXX
06019L0001
199,00 €

Caixa de cartão
06019L0000
159,00 €

PLAINA



GHO 12V-20

Mala L-BOXX
06015A7002
261,00 €

Caixa de cartão
06015A7000
240,00 €

TESOURA



GSC 12V-13

Mala L-BOXX
060192610A
314,00 €

Caixa de cartão
0601926105
293,00 €

ASPIRADOR



GAS 12V

Mala L-BOXX
06019E3001
121,00 €

Caixa de cartão
06019E3000
97,00 €

MULTIFERRAMENTA ROTATIVA



GRO 12V-35

Mala L-BOXX
06019C5002
142,00 €

Caixa de cartão
06019C5000
121,00 €

SERRA CIRCULAR

GWS 12V-76

Mala L-BOXX
06019F2003
156,00 €

Caixa de cartão
06019F2000
135,00 €



GKS 12V-26

Mala L-BOXX
06016A1002
156,00 €

Caixa de cartão
06016A1001
135,00 €

SERRA VERTICAL



GST 12V-70

Mala L-BOXX
06015A1002
146,00 €

Caixa de cartão
06015A1001
125,00 €

SERRA SABRE



GSA 12V-14

Mala L-BOXX
060164L905
151,00 €

Caixa de cartão
060164L902
130,00 €

POWER SETS (BATERIAS E CARREGADOR)



GAL 12V-40
1600A019R3
46,00 €



GAX 18V-30
1600A011A9
51,00 €

Para 12V, 14,4 e 18V

POWER SETS



Power Set 2 baterias 12V 2,0 Ah + Carregador GAL 12V-40
1600A019R8
93,00 €

Power set 2 baterias 12V 3,0 Ah + Carregador GAL 12V-40
1600A019RD
114,00 €



Power Set 1 batería 12V 2,0 Ah + 1 batería 12V 4,0 Ah + Carregador GAL 12V-40
1600A01NC9
114,00 €



Power Set 2 baterias 12V 6,0 Ah + Carregador GAL 12V-40
1600A01B20
167,00 €



Berbequim/Aparafusadora
GSR 12V-15

060186810F

BERBEQUIM/APARAFUSADORA 12V
0,95kg, 2 Velocidades, c/ 20 posições de bi-
nário + posição perfuração e bucha porta
brocas 10mm + Mala de lona

060186810H

[C/Jogo 25 Acessórios] - **149,00 €**



C/2 Baterias 12V
2,0Ah



146,00 €

2 Uni - 142,00 €



Berbequim/Aparafusadora
GSR 12V-15

061599066L

BERBEQUIM/APARAFUSADORA 12V
0,95kg, 2 Velocidades, c/ 20 posições de bi-
nário + posição perfuração e bucha porta
brocas 10mm + 39 Acessórios + Mala de lona



C/1 Baterias 12V
2,0Ah



C/1 Baterias 12V
4,0Ah



177,00 €



Aparafusadora
GSR 12V-15 FC SET

06019F6000

APARAFUSADORA C/ SISTEMA FLEX CLICK
, 12V, 1/4" Hex, Bucha 10mm, 2 Velocidades.
c/ 4 Adaptadores: GFA 12 B (Bucha), GFA 12
E (Exêntrico), GFA 12 W (Angular), GFA 12 X
(Porta Bit 1/4)

06019F6001

GSR 12V-15 FC + Adaptador GFA 12B - **209,00 €**



C/2 Baterias
12V 2,0Ah

4 em 1
4 soluções numa
só máquina



289,00 €



IDEAL PARA PLADUR

Aparafusadora p/Pladur
GTB 12V-11

06019E4003 + KIT BAT 3.0AH

APARAFUSADORA P/ PLADUR c/ batente de
profundidade. Motor EC. 0-3.000rpm. 0,9kg.
Em L-Boxx.



C/2 Baterias
12V 3,0Ah



270,00 €



APARAFUSADORA RETA
BOSCH GO

06019H2101

3,6V. 360 rpm, 5/2,5 Nm. Bateria integrada
1,5Ah. 2 modos de
activação (premindo ou com o botão "on"). 5
posições de ajuste. Inserção 1/4". Mini cabo
USB, carregador,
set de 25 bit's, Mini BOXX.

78,00 €

2 Uni - 70,00 €



Berbequim c/Percussão
GSB 12V-15

06019B690H

BERBEQUIM C/ PERCUSSÃO 12V
c/ 2 Velocidades, 20 Posições de Binário
e Bucha Porta Brocas 10mm Função de
Percussão.

Mala de lona. 1,1kg



C/2 Baterias 12V
2,0Ah



158,00 €

2 Uni - 155,00 €



Berbequim c/Percussão
GSB 12V-15

06019B690G

BERBEQUIM C/ PERCUSSÃO 12V
c/ 2 Velocidades, 20 Posições de Binário
e Bucha Porta Brocas 10mm Função de
Percussão.

C/38 Acessorios + Bolsa Transporte. 1,1kg



C/1 Baterias 12V
2,0Ah



C/1 Baterias 12V
4,0Ah



188,00 €



GDR 12V-105

GSB 12V-15

APARAFUSADORA IMPACTO HEXG 1/4"
GDR 12V-105

0615990L9C

12V.13,7x17,8cm. 0-3.100Rpm. M4-M12. 105Nm.
Luz Integrada. Travão elétronico.

C/ Oferta de Berbequim com percussão
GSB 12V-15 Professional



C/2 Baterias 12V
2,0Ah



SL

293,00 €



Berbequim/Aparafusadora Angular
GWB 12V-10

0601390908

BERBEQUIM/APARAFUSADORA ANGULAR.

0-1300rpm. Ø Máx. parafuso: 7mm.

Luz integrada.

5 Posições diferentes de cabeça.

Cabeça ajustável até 90°.

Em L-Boxx



C/2 Baterias 12V
2,0Ah



209,00 €



SERRA SABRE
GSA 12V-14

060164L905 + KIT BATERIAS 3.0Ah

12V. Comprimento do curso: 14,5 mm.

0-3.000 cpm. Sistema de substituição da

lâmina sem necessidade de ferramentas.

Regulação da velocidade no interruptor. Luz

LED. Indicador de carga da bateria.1,2 Kg.



C/2 Baterias 12V
3,0Ah



265,00 €

RETIFICADORAS DIREITAS

| | | | |
|---|--|--|--|
| | | | |
| GGS 18V-20 Mala L-BOXX 06019B5400 219,00 € Caixa de cartão 06019B5401 209,00 € | GGS 18V-23 LC Mala L-BOXX 0601229100 282,00 € CONNECTED | GGS 18V-23 PLC Mala L-BOXX 0601229200 293,00 € Interruptor "Homem morto" | GGS 18V-10 SLC Mala L-BOXX 06012B4000 377,00 € Caixa de cartão 06012B4001 356,00 € 3 Velocidades |

ASPIRADORES

| |
|--|
| |
| GAS 18V-1 Caixa de cartão 06019C6200 104,00 € |

APARAFUSADORAS

| | | | | |
|---|---|--|--|--|
| | | | | |
| GSR 18V-55 Mala L-BOXX 06019H5203 188,00 € Caixa de cartão 06019H5202 167,00 € | GSR 18V-90 C Mala L-BOXX 06019K6002 229,00 € Caixa de cartão 06019K6000 209,00 € CONNECTED | GSR 18V-60 FC Mala L-BOXX 06019G7102 261,00 € Full Set (4 Accesorios) 06019G7103 356,00 € CONNECTED | GSR 18V-110 C Mala L-BOXX 06019G0109 251,00 € Caixa de cartão 06019G0108 230,00 € CONNECTED | GSR 18V-150 C Mala L-BOXX 06019J5002 310,00 € Caixa de cartão 06019J5001 289,00 € CONNECTED |

BERBEQUINS COM PERCUSSÃO

| | |
|--|--|
| | |
| GSB 18V-110 C Mala L-BOXX 06019G030A 261,00 € Caixa de cartão 06019G0309 240,00 € CONNECTED | GSB 18V-150 C Mala L-BOXX 06019J5102 320,00 € Caixa de cartão 06019J5101 299,00 € CONNECTED |

APARAFUSADORAS / CHAVES DE IMPACTO

| | |
|--|--|
| | |
| GDR 18V-160 Mala L-BOXX 06019G5104 146,00 € Caixa de cartão 06019G5106 125,00 € 1/4" | GDR 18V-200 Mala L-BOXX 06019J2106 198,00 € Caixa de cartão 06019J2105 177,00 € 1/4" |

CHAVES DE IMPACTO

| | | | |
|---|--|---|---|
| | | | |
| GDS 18V-1000 Mala L-BOXX 06019J8301 335,00 € Caixa de cartão 06019J8300 314,00 € 1/2" | GDS 18V-1000 C Mala L-BOXX 06019J8001 345,00 € Caixa de cartão 06019J8000 324,00 € 1/2" CONNECTED Inclui módulo de conexão Bluetooth | GDS 18V-1050 H Mala L-BOXX 06019J8501 335,00 € Caixa de cartão 06019J8500 314,00 € 3/4" | GDS 18V-1050 HC Mala L-BOXX 06019J8201 345,00 € Caixa de cartão 06019J8200 324,00 € CONNECTED 3/4" Inclui módulo de conexão Bluetooth |

LIXADORAS ORBITAIS

| | |
|---|--|
| | |
| GSS 18V-10 Mala L-BOXX 06019D0202 192,00 € Caixa de cartão 06019D0200 156,00 € | NOVIDADE GSS 18V-13 Mala L-BOXX 06019L0101 239,00 € Caixa de cartão 06019L0100 189,00 € |

LIXADORA EXCÊNTRICA

| |
|--|
| |
| GEX 18V-125 Mala L-BOXX 0601372200 209,00 € Caixa de cartão 0601372201 188,00 € |

ROEDORA

| |
|--|
| |
| NOVIDADE GNA 18V-16 E Caixa de cartão 0601529600 513,00 € |

TESOURA

| |
|--|
| |
| NOVIDADE GSC 18V-16 E Caixa de cartão 0601926300 471,00 € |

SÓ O QUE NECESSITAS



Se já tens baterias e carregadores, compra as ferramentas que necessitas de forma individual para ampliar o teu equipamento de trabalho.

Necessitas de mais baterias e carregadores?



FERRAMENTAS SEM Baterias nem Carregadores

SOPLADOR A BATERIA



GAS 18V-10 L
Caixa de cartão
06019C6302
168,00 €

Con ruedas y accesorios



GBL 18V-120
Caixa de cartão
06019F5100
87,00 €

APARAFUSADORAS



GSR 18V-21
Mala L-BOXX
06019H1009
146,00 €
Caixa de cartão
06019H1071
125,00 €



GSR 18V-28
Mala L-BOXX
06019H4108
173,00 €
Caixa de cartão
06019H4100
156,00 €



GSR 18V-45
Mala L-BOXX
06019k3201
169,00 €
Caixa de cartão
06019k3200
149,00 €

BERBEQUINS COM PERCUSSÃO



GSB 18V-21
Mala L-BOXX
06019H1108
151,00 €
Caixa de cartão
06019H1176
130,00 €



GSB 18V-28
Mala L-BOXX
06019H4008
188,00 €
Caixa de cartão
06019H4000
167,00 €



GSB 18V-45
Mala L-BOXX
06019K3301
179,00 €
Caixa de cartão
06019K3300
159,00 €



GSB 18V-55
Mala L-BOXX
06019H5303
198,00 €
Caixa de cartão
06019H5302
177,00 €



GSB 18V-90 C
Mala L-BOXX
06019K6102
239,00 €
Caixa de cartão
06019K6100
219,00 €
CONNECTED



GDR 18V-210 C
Mala L-BOXX
06019J0101
236,00 €
Caixa de cartão
06019J0100
209,00 €
CONNECTED 1/4"



GDS 18V-210 C
Mala L-BOXX
06019J0301
236,00 €
Caixa de cartão
06019J0300
209,00 €
CONNECTED 1/2"



GDS 18V-300
Mala L-BOXX
06019D8201
247,00 €
Caixa de cartão
06019D8200
226,00 €
1/2"



GDS 18V-450 HC
Mala L-BOXX
06019K4001
279,00 €
Caixa de cartão
06019K4000
249,00 €
1/2"



APARAFUSADORAS DE IMPACTO



GDX 18V-200
Mala L-BOXX
06019J2205
209,00 €
Caixa de cartão
06019J2204
188,00 €
1/2" + 1/4"



GDX 18V-210 C
Mala L-BOXX
06019J0201
247,00 €
Caixa de cartão
06019J0200
219,00 €
CONNECTED 1/2" + 1/4"



PLAINA



GHO 18V-LI
Mala L-BOXX
06015A0300
235,00 €
Caixa de cartão
06015A0307
214,00 €



NOVIDADE
GCU 18V-30
Caixa de cartão
06019K8000
199,00 €

PREGADORA



GNH 18V-64 M
Mala L-BOXX
0601481001
555,00 €
Caixa de cartão
0601481000
535,00 €

REBITADORA



GRG 18V-16 C
Mala L-BOXX
06019K5002
807,00 €
Caixa de cartão
06019K5000
786,00 €
CONNECTED

APARAFUSADORA GESSO CARTONADO



NOVIDADE
GTB 18V-45
Mala L-BOXX
06019K7001
209,00 €
Caixa de cartão
06019K7000
189,00 €

SERRA DE MEIA ESQUADRIA



BITURBO
BRUSHLESS
GCM 18V-216
Caixa de cartão
0601B41000
566,00 €

LANTERNAS E PROJETORES



GLI 18V-300
Caixa de cartão
06014A1100
62,00 €



GLI 18V-1200 C
Caixa de cartão
0601446700
104,00 €
CONNECTED



GLI 18V-1900
Caixa de cartão
0601446400
121,00 €



GLI 18V-2200 C
Caixa de cartão
0601446501
156,00 €
CONNECTED



MARTELOS SDS Plus BRUSHLESS



GBH 18V-21
Mala L-BOXX
0611911101
240,00 €
Caixa de cartão
0611911100
219,00 €
2,0J



NOVEDAD
GBH 18V-24 C
Mala L-BOXX
0611923001
289,00 €
Caixa de cartão
0611923000
269,00 €
2,4J **CONNECTED**



GBH 18V-26 D
Mala
0611916000
293,00 €
2,6J



GBH 18V-26
Mala L-BOXX
0611909001
331,00 €
2,6J



GBH 18V-26 F
Mala L-BOXX
0611910001
352,00 €
Caixa de cartão
0611910000
331,00 €
Portabrocas adicional 2,6J

MINIREBARBADORAS BRUSHLESS

GWS 18V-7



| | |
|--|--|
| (115 mm) Mala L-BOXX 06019H9004 172,00 € Caixa de cartão 06019H9003 151,00 € | (125 mm) Mala L-BOXX 06019H9002 172,00 € Caixa de cartão 06019H9001 151,00 € |
|--|--|

Equivalente a 700 W

GWS 18V-10



| | |
|--|--|
| (115 mm) Mala L-BOXX 06019J4001 198,00 € Caixa de cartão 06019J4000 177,00 € | (125 mm) Mala L-BOXX 06019J4003 198,00 € Caixa de cartão 06019J4002 177,00 € |
|--|--|

Equivalente a 1.000 W



GWS 18V-10 PC (125 mm)
Mala L-BOXX
06019G3E0B
251,00 €
CONNECTED
Interruptor "Homem morto"
Equivalente a 1.000 W



GWS 18V-10 PSC (125 mm)
Mala L-BOXX
06019G3F0B
293,00 €
CONNECTED
Inclui módulo de conexão Bluetooth
Interruptor "Homem morto"
Equivalente a 1.000 W
Regulação de velocidade

MINIREBARBADORAS BRUSHLESS

GWX 18V-7



| | |
|--|--|
| (115 mm) Mala L-BOXX 06019H9104 188,00 € Caixa de cartão 06019H9103 167,00 € | (125 mm) Mala L-BOXX 06019H9102 188,00 € Caixa de cartão 06019H9101 167,00 € |
|--|--|

Equivalente a 700 W



GWX 18V-10 (125 mm)
Mala L-BOXX
06017B0101
219,00 €
Caixa de cartão
06017B0100
198,00 €
Equivalente a 1.000 W



GWX 18V-10 PC
Mala L-BOXX
06017B0700
278,00 €
CONNECTED
Interruptor "Homem morto"
Equivalente a 1.000 W



GWX 18V-10 SC
Mala L-BOXX
06017B0400
314,00 €
Equivalente a 1.000 W
Regulação de velocidade
CONNECTED
Inclui módulo de conexão Bluetooth



GWX 18V-10 PSC (125mm)
Mala L-BOXX
06017B0800
314,00 €
Equivalente a 1.000 W
Regulação de velocidade
CONNECTED
Inclui módulo de conexão Bluetooth

XLOCK

SÓ O QUE NECESSITAS



Se já tens baterias e carregadores, compra as ferramentas que necessitas de forma individual para ampliar o teu equipamento de trabalho.

Necessitas de mais baterias e carregadores?

RÁDIOS



GLI 18V-4000 C
Caixa de cartão
0601446800
230,00 €
CONNECTED



GLI 18V-10000 C
Caixa de cartão
0601446900
324,00 €
CONNECTED



GPB 18V-2 C
Caixa de cartão
06014A3000
146,00 €
CONNECTED



GPB 18V-5 C
Caixa de cartão
06014A4000
261,00 €

MARTELOS SDS max BRUSHLESS



GBH 18V-28 DC
Mala
0611919000
324,00 €
CONNECTED



BITURBO
BRUSHLESS
GBH 18V-34 CF
Em mala
0611914001
618,00 €
CONNECTED



Portabrocas adicional 5,8 J



BITURBO
BRUSHLESS
GBH 18V-36 C
Em mala
0611915001
671,00 €
CONNECTED



7,0 J



BITURBO **NOVEDAD**
BRUSHLESS
GBH 18V-40 C
En Mala L-BOXX XL
0611917100
749,00 €
CONNECTED

9,0 J



BITURBO
BRUSHLESS
GBH 18V-45 C
Em mala
0611913000
996,00 €
CONNECTED



12,5 J



GWS 18V-10 SC
(125 mm)
Mala L-BOXX
06019G340B
303,00 €
(150 mm)
Mala L-BOXX
06019G350B
314,00 €
CONNECTED



Equivalente a 1.000 W
Regulação de velocidade



BITURBO
BRUSHLESS
GWS 18V-15 C
(125 mm)
Mala L-BOXX
06019H6000
320,00 €
CONNECTED

Equivalente a 1.500 W



GWS 18V-15 SC
(125 mm)
Mala L-BOXX
06019H6100
345,00 €
(150 mm)
Mala L-BOXX
06019H6300
377,00 €
CONNECTED



Equivalente a 1.500 W
Regulação de velocidade



BITURBO **NOVEDAD**
BRUSHLESS
GWS 18V-15 P
(125 mm)
Mala L-BOXX
06019H6A01
315,00 €
Caixa de cartão
06019H6A00
295,00 €
CONNECTED

Equivalente a 1.500 W
Interruptor "Homem morto"



BITURBO **NOVEDAD**
BRUSHLESS
GWS 18V-15 PSC (125 mm)
Mala L-BOXX
06019H6B02
339,00 €
Caixa de cartão
06019H6B00
319,00 €
CONNECTED



Equivalente a 1.500 W
Regulación de velocidad
Interruptor "Homem morto"

REBARBADORA



GWX 18V-15 C
Mala L-BOXX
06019H6400
345,00 €
CONNECTED

Equivalente a 1.500 W
Regulação de velocidade



GWX 18V-15 SC
Mala L-BOXX
06019H6500
377,00 €
CONNECTED

Equivalente a 1.500 W
Regulação de velocidade



GWX 18V-15 P
(125 mm)
Mala L-BOXX
06019H6F01
335,00 €
NOVEDAD
BITURBO
BRUSHLESS

Caixa de cartão
06019H6F00
315,00 €

Equivalente a 1.500 W
Interruptor "Homem morto"



GWX 18V-15 PSC
(125 mm)
Mala L-BOXX
06019H6G02
359,00 €
CONNECTED

Caixa de cartão
06019H6G00
339,00 €

Equivalente a 1.500 W
Interruptor "Homem morto"



BITURBO
BRUSHLESS

Regulação de velocidade



GWS 18V-180 PC (180 mm)
Caixa de cartão
06019H6E01
309,00 €
CONNECTED

Equivalente a 1.500 W
Interruptor "Homem morto"

MULTIHERRAMIENTA



GOP 18V-28
Mala L-BOXX
06018B6001
247,00 €
Caixa de cartão
06018B6002
226,00 €

PISTOLAS DE SILICONA



GCG 18V-310
Caixa de cartão
06019C4100
345,00 €

3,5 kN Cartucho



GCG 18V-600
Caixa de cartão
06019C4001
356,00 €

3,5 kN Cartucho Bolsa

DECAPADOR DE AIRE CALIENTE



GHG 18V-50
Mala L-BOXX
06012A6501
198,00 €
Caixa de cartão
06012A6500
177,00 €

SIERRA DE MESA



BITURBO
BRUSHLESS
GTS 18V-216
Caixa de cartão
0601B44000
755,00 €

SIERRAS CIRCULARES



GKS 18V-57
Caixa de cartão
06016A2200
173,00 €



NOVEDAD
GKS 18V-57-2
Mala L-BOXX
06016C1201
269,00 €
Caixa de cartão
06016C1200
239,00 €



GKS 18V-57 G
Mala L-BOXX
06016A2101
240,00 €
Posibilidad de acoplar carril guía

SIERRAS CIRCULARES



BITURBO
BRUSHLESS
GKS 18V-68 C
Mala L-BOXX
06016B5001
387,00 €
Caixa de cartão
06016B5000
366,00 €

CONNECTED



BITURBO
BRUSHLESS
GKS 18V-68 GC
Mala L-BOXX
06016B5100
450,00 €
Posibilidad de acoplar carril guía

CONNECTED



NOVEDAD
GKS 18V-70 L
Mala L-BOXX
06016B9001
439,00 €
Caixa de cartão
06016B9000
419,00 €

SIERRAS CIRCULARES



GKS 18V-LI
Mala L-BOXX
060166H006
247,00 €



NOVEDAD
GKM 18V-50
Mala L-BOXX
06016B8001
279,00 €
Caixa de cartão
06016B8000
259,00 €

Para metal



BITURBO
BRUSHLESS
GKT 18V-52 GC
Mala L-BOXX
06016B4000
471,00 €

CONNECTED

Inclui módulo de conexão Bluetooth

Posibilidad de acoplar carril guía

SIERRAS DE CALAR



GST 18V-LI B
Mala L-BOXX
06015A6101
240,00 €
Caixa de cartão
06015A6100
219,00 €



GST 18V-LI S
Mala L-BOXX
06015A5101
230,00 €



NOVEDAD
GST 18V-125 B
Mala L-BOXX
06015B3000
249,00 €
Caixa de cartão
06015B3001
229,00 €



NOVEDAD
GST 18V-155 SC
Mala L-BOXX
06015B0000
299,00 €
Caixa de cartão
06015B0001
279,00 €

CONNECTED



NOVEDAD
GST 18V-155 BC
Mala L-BOXX
06015B1000
299,00 €
Caixa de cartão
06015B1001
279,00 €

CONNECTED

SIERRA DE CINTA



GCB 18V-63
Mala L-BOXX
06012A0401
251,00 €
Caixa de cartão
06012A0400
230,00 €



GSA 18V-LI C
Mala L-BOXX
06016A5001
188,00 €
Caixa de cartão
06016A5004
167,00 €



GSA 18V-LI
Mala L-BOXX
060164J007
219,00 €
Caixa de cartão
060164J000
198,00 €



GSA 18V-28
Mala L-BOXX
06016C0001
319,00 €
Caixa de cartão
06016C0000
289,00 €

NOVEDAD
BITURBO
BRUSHLESS



GSA 18V-32
Caixa de cartão
06016A8108
366,00 €

SÓ O QUE NECESSITAS



Se já tens baterias e carregadores, compra as ferramentas que necessitas de forma individual para ampliar o teu equipamento de trabalho.

Necessitas de mais baterias e carregadores?

BATERIAS, CARGADORES Y PACKS DE BATERIAS Y CARGADOR

BATERIAS



GBA 18V 2,0 Ah
1600Z00036
60,00 €
285351820



GBA 18V 4,0 Ah
1600Z00038
80,00 €
285351840



GBA 18V 5,0 Ah
1600A002U5
96,00 €
285351850

ProCORE 18V



ProCORE 18V 4,0 Ah
1600A016GB
93,00 €
285351910



ProCORE 18V 5,5 Ah
1600A02149
146,00 €
285351915



ProCORE 18V 8,0 Ah
1600A016GK
169,00 €
285351920



ProCORE 18V 12,0 Ah
1600A016GU
256,00 €
285351930

CARGADORES



Multi-GAX 18V-30
1600A011A9
51,00 €
285385415



GAL 18V-40
1600A019RJ
48,00 €
285385540



GAL 1880 CV
1600A00B8G
83,00 €
285385450



CONNECTED
GAL 18V-160 C
1600A019S5
114,00 €
285385460



CONNECTED
GAL 18V-160
1600A019S6
137,00 €
285385461



GAL 18V6-80
1600A01U9L
125,00 €

Multicarregador: hasta 6 baterías
285385550

STARTER SETS / POWER SETS



Starter Set 1 batería 18V 4,0 Ah + Cargador GAL 18V-40
1600A01B9Y
112,00 €
285373390 (LB 7038)



Power Set 2 baterías 18V 4,0 Ah + Cargador GAL 18V-40
1600A019S0
188,00 €
285373400 (LB 6950)



Power Set 2 baterías 18V 5,0 Ah + Cargador GAL 1880 CV
1600A00B8J
219,00 €
285373500 (LB 7026)

ProCORE 18V



Starter Set 1 batería ProCORE 18V 4,0 Ah + Cargador GAL 18V-40
1600A01U7U
135,00 €
(LB 7034)



Power Set 2 baterías ProCORE 18V 4,0 Ah + Cargador GAL 18V-40
1600A01BA3
215,00 €
285373310 (LB 7000)



Power set 1 batería ProCORE 18V 4,0 Ah + 1 batería ProCORE 18V 5,5 Ah + Cargador GAL 1880 CV
1600A0214A
261,00 €
285373315 (LB 7022)



Power set 2 baterías ProCORE 18V 5,5 Ah + Cargador GAL 1880 CV
1600A0214C
314,00 €
285373325 (LB 7028)



Power Set 2 baterías ProCORE 18V 8,0 Ah + Cargador GAL 18V-160 C
1600A016GP
314,00 €
285373330 (LB 7030)



Power Set 2 baterías ProCORE 18V 12,0 Ah + Cargador GAL 18V-160 C
1600A016GY
366,00 €
285373340



PACKS 18V



X6
Pack 6 baterías 18V Professional
6 Baterías 18V 4,0 Ah + Mala L-BOXX 136
1600A02A2S
408,00 €



X4
Pack 4 baterías 18V Professional
4 baterías ProCORE 18V 5,5 Ah + Mala L-BOXX 136
1600A02A2U
513,00 €



X4 X2
Pack 6 baterías 18V Professional
6 baterías ProCORE 18V: 4x4,0 Ah + 2x8,0 Ah + Mala L-BOXX 136
1600A02A2T
650,00 €

AMP Share | PARCEIROS UNIVERSAIS DE BATERIAS



A partir de agora, as marcas de ferramentas a bateria que fazem parte de da nova aliança **AMPShare** podem utilizar qualquer bateria e carregador **Bosch Professional 18V**.



Mantém-te sempre informado de todas as marcas la aliança **AMPShare** de Bosch en <https://www.professional-18vsystem.com/pt/pt/>



GDR 18V-160 + GSB 18V-21

0615990L41

Composto por:

- Aparafusadora de impacto hexagonal 1/4", 160Nm, 0-2.800 rpm. 0-3.600 ipm. Luz LED.

1,37 Kg. **GDR 18V-160**

- Berbequim c/ percussão **GSB 18V-21**

278,00 €



GDV 18V-200 + GSR 18V-55

06019J2207

Composto por:

- Chave de Impacto quadra 1/2" + Aparafusadora de impacto hexagonal 1/4", **GDV 18V-200**

- Berbequim/Aparafusadora **GSR 18V-55**

450,00 €



GDV 18V-200 + GSB 18V-55

06019J2208

Composto por:

- Chave de Impacto quadra 1/2" + Aparafusadora de impacto hexagonal 1/4", **GDV 18V-200**

- Berbequim c/ percussão **GSB 18V-55**

440,00 €



BERBEQUIM/APARAFUSADORA 18V
GSR 18-2 Li (Compact)

06019B7305

BERBEQUIM/APARAFUSADORA 18V Compacto; 2 Velocidades 0-450/1.400rpm; 17/38Nm 15 Posições de binário + Posição de perfuração; 1,3kg; Bucha 10mm. Ø Máximo de parafuso 7mm. Em mala L-Case.



2 Baterias 18V
2,0Ah



184,00 €



BERBEQUIM/APARAFUSADORA 18V
GSR 18V-21

0615990L88

BERBEQUIM/APARAFUSADORA ECP-EMP 18 V Li; 55/21Nm. 2 Velocidades (0-480/1.800rpm). 20 Posições de binário + Posição Perfuração; 1,5kg. Em L-CASE. Bucha 13mm



3 Baterias 18V
2,0Ah



06019H1008

(C/2BAT 2.0Ah + Mala L-Boxx) - **219,00 €**

06019H100C

(C/2BAT 4.0Ah + 82 Acessórios + Mala L-Case) - **278,00 €**



230,00 €



BERBEQUIM C/ PERCUSSÃO 18 V
GSB 18-2-LI Profissional

0615990K45 SL

BERBEQUIM C/ PERCUSSÃO 18 V 2 Velocidades. Posição Perfuração (Percussão). 0-500/1.900rpm. Bucha 1,5-10mm. 1.5kg. Em mala de lona.



2 Baterias 18V
1,5Ah



06019D2303

(C/2BAT 2.0Ah + Mala L-Case) - **205,00 €**

191,00 €



BERBEQUIM C/ PERCUSSÃO 18 V
GSB 18V-21

0615990K41

BERBEQUIM C/ PERCUSSÃO 18 V 2 Velocidades(0-480/1800rpm).55/21Nm 20 Posições de binário + Posição Perfuração (Percussão). Luz integrada. Bucha 1,5-13mm. 1.6kg. Em mala de lona.



2 Baterias 18V
2,0Ah



06019H110B

(C/2BAT 2.0Ah + 63 Acessórios + Mala L-Case) - **236,00 €**

06019H110C

(C/2BAT 4.0Ah + 82 Acessórios + Mala L-Case) - **289,00 €**



205,00 €



INCLUI 82 ACESSÓRIOS
no valor de 120€

| Pontas extra hard | 25 mm | 65 mm |
|-------------------|---|---|
| PH | 1 (x2) / 2 (x8) / 3 (x2) | 2 (x3) |
| PZ | 1 (x2) / 2 (x7) / 3 (x2) | 2 (x2) |
| S | 3 / 4 / 5 / 6 | 6 (x2) |
| H | 3 / 4 / 5 / 6 | 3 / 4 |
| T | 10 / 15 / 20 (x4) / 25 / 27 / 30 / 40 | 15 (x2) / 20 (x2) / 25 (x2) |
| Porta-pontas | Brocas Madeira Ø 3 / 4 / 5 / 6 / 7 / 8 / 10 mm | 2x |
| Brocas Metal | Ø 2 / 3 / 4 / 5 / 6 / 7 / 8 / 10 mm | Brocas Alvenaria Ø 3 / 4 / 2x5 / 2x6 / 8 / 10 mm |



Aparafusadora
GSR 18V-28



06019E610C

18V. 2 Velocidades (0-500/1.900 rpm).
63/28 Nm; 20+1. Bucha de 13 mm. Luz LED.
Inclui: 82 acessórios.
2 Baterias de 4,0 Ah.
1 Carregador GAL 18V-20. L-CASE.

303,00 €



Aparafusadora
GSR 18V-45



06019K3205

18V. 2 Velocidades (0-450/1.900 rpm).
45/21 Nm. Bucha de 13 mm. Luz LED.
Inclui: 82 acessórios.
2 Baterias de 2,0 Ah.
1 Carregador GAL 18V-20. L-CASE.

239,00 €



Aparafusadora
GSR 18V-55



06019H5209

18V. 2 Velocidades (0-450/1.750 rpm).
55/28 Nm. 20+1. Bucha de 13 mm. Luz LED.
Inclui: 82 acessórios.
2 Baterias de 4,0 Ah.
1 Carregador GAL 18V-20. L-CASE.

314,00 €



Aparafusadora
GSR 18V-28

06019H410A

C/2 Bat. 4.0Ah + L-Case

282,00 €



Aparafusadora
GSR 18V-45

06019K3203

C/2 Bat. 2.0Ah + L-Boxx

225,00 €

06019K3204

C/2 Bat. 3.0Ah + L-Boxx

239,00 €



Aparafusadora
GSR 18V-55

06019H5204

C/2 Bat. 4.0Ah ProCORE + L-Boxx

310,00 €

0601990L8D

C/3 Bat. 5.0Ah + L-Boxx

398,00 €



MOTOR S/ESCOVAS

Berbequim/Aparafusadora GSR 18V-90 C

06019K6004

18V. CONNECTED. Motor S/ESCOVAS. KickBack Control. ECP. EMP. 2 Velocidades (0-630/2.100 rpm). 90/35 Nm. Ø Máx. parafuso: 13 mm. Ø Máx.perfuração em madeira: 68 mm. 1,1 Kg.

06019K6006

(C/2BAT 5.0Ah + Mala L-BOXX) - **369,00 €**



2 Baterias 18V 4,0Ah ProCORE



345,00 €



MOTOR S/ESCOVAS

Berbequim/Aparafusadora GSR 18V-110 C

0615990L8F

18V. CONNECTED. KickBack Contro. ECP.EM 2 Velocidades. 0-480/2.100rpm. 85/47Nm. ØMáx Parafuso 12mm. Ø Máx perfuração madeira 82mm.

06019G010A

(C/2BAT 4.0Ah ProCORE + Mala L-BOXX) - **450,00 €**



2 Baterias 18V 5,0Ah



503,00 €



MOTOR S/ESCOVAS BITURBO BRUSHLESS

Berbequim/Aparafusadora GSR 18V-150 C

06019J5005

18V. BITURBO. CONNECTED. Motor S/Escovas. KickBack Control. ECP. EMP Detecção eletrónica de ângulos. 2 Velocidades (0-550/2.200 rpm). 0-33.000 ipm. Binário máx. 150Nm. Ø Máx. parafuso: 12 mm. Ø Máx. perfuração em madeira: 150 mm.



2 Baterias ProCORE 18V 8,0Ah



597,00 €



INCLUI 82 ACESSÓRIOS
no valor de 120€

| Pontas extra hard | 25 mm | 65 mm |
|-------------------|---|---|
| PH | 1 (x2) / 2 (x8) / 3 (x2) | 2 (x3) |
| PZ | 1 (x2) / 2 (x7) / 3 (x2) | 2 (x2) |
| S | 3 / 4 / 5 / 6 | 6 (x2) |
| H | 3 / 4 / 5 / 6 | 3 / 4 |
| T | 10 / 15 / 20 (x4) / 25 / 27 / 30 / 40 | 15 (x2) / 20 (x2) / 25 (x2) |
| Porta-pontas | Brocas Madeira Ø 3 / 4 / 5 / 6 / 7 / 8 / 10 mm | 2x |
| | Brocas Metal Ø 2 / 3 / 4 / 5 / 6 / 7 / 8 / 10 mm | Brocas Alvenaria Ø 3 / 4 / 2x5 / 2x6 / 8 / 10 mm |



Berbequim C/Percussão
GSB 18V-28



06019E710B

18V. 2 Velocidades (0-500/1.900 rpm).
63/28 Nm; 20+1. Sistema de percussão
Bucha de 13 mm. Luz LED.
Inclui: 82 acessórios. 2 Baterias de
4,0 Ah. 1 Carregador GAL 18V-20. L-CASE.

314,00 €



Berbequim C/Percussão
GSB 18V-45



06019K3306

18V. 2 Velocidades (0-500/1.900 rpm).
45/21 Nm. Sistema de percussão
Bucha de 13 mm. Luz LED.
Inclui: 82 acessórios. 2 Baterias de 2,0 Ah.
1 Carregador GAL 18V-20. L-CASE.

249,00 €



Berbequim C/Percussão
GSB 18V-55



06019H530A

18V. 2 Velocidades (0-450/1.750 rpm).
55/28 Nm. Sistema de percussão
20+1. Bucha de 13 mm. Luz LED.
Inclui: 82 acessórios. 2 Baterias de
4,0 Ah. 1 Carregador GAL 18V-20. L-CASE.

324,00 €



Berbequim C/Percussão
GSB 18V-28

06019H400B

C/2 Bat. 2.0Ah + L-Case

244,00 €

06019H400C

C/2 Bat. 4.0Ah + L-Boxx

303,00 €



Berbequim C/Percussão
GSB 18V-45

06019K3303

C/2 Bat. 2.0Ah + L-Boxx

235,00 €

06019K3305

C/2 Bat. 3.0Ah + L-Boxx

249,00 €



Berbequim C/Percussão
GSB 18V-55

06019H5304

C/2 Bat. 4.0Ah ProCORE + L-Boxx

314,00 €

0601990L86

C/3 Bat. 5.0Ah + L-Boxx

408,00 € SL



MOTOR S/ESCOVAS

Berbequim c/ Percussão
GSB 18V-90 C

06019K6104

18V. CONNECTED.
KickBack Control. ECP.EMP. 2 Velocidades
0-600/2.100rpm. 90/35Nm. 28.500ipm. Sistema de
percussão. Ø Máx parafuso 10mm.
Ø Máx perfuração madeira 68mm. 1,1kg.

06019K6106

(C/2BAT 5.0Ah + Mala L-BOXX) - **379,00 €**



2 Baterias 18V
4,0Ah ProCORE



355,00 €



MOTOR S/ESCOVAS

Berbequim c/ Percussão
GSB 18V-110 C

0615990L87

18V. CONNECTED. KickBack Control. ECP.EMP
2 Velocidades 0-480/2.100rpm. 85/47Nm.
Sistema de percussão.
Ø Máx. Parafuso 12mm.
Ø Máx perfuração madeira 82mm.

06019G0303

(C/2BAT 4.0Ah ProCORE + Mala L-BOXX) - **461,00 €**



2 Baterias
18V 5,0Ah



513,00 €



MOTOR S/ESCOVAS BITURBO BRUSHLESS

Berbequim c/ Percussão
GSB 18V-150 C

06019J5105

18V. BITURBO. CONNECTED Motor S/Escovas.
KickBack Control. ECP.EMP.
Detecção eletrónica de ângulos. 2 Velocidades
(0-550/2.200 rpm). 0-33.000 ipm. Binário máx.
150Nm. Sistema de percussão.
ØMáx. parafuso: 12 mm.
Ø Máx. perfuração em madeira: 150 mm.



2 Baterias
ProCORE
18V 8,0Ah



618,00 €



Aparafusadora
GSR 18V-60 FC

06019G7103 + KIT BATERIAS

Sistema FlexiClick.
MOTOR EC. 1/4" HEX. Bucha de 13mm.
2 Velocidades: 0-500/1.700rpm.
18 Posições de binário + posição de perfuração.
31/50Nm. 1,7kg. L-BOXX

Num só click, cinco ferramentas numa só.



C/2 Baterias
ProCORE 18V
4,0Ah

571,00 €

Aparafusadora de Impacto HEXAG 1/4"
GDR 18V-160

06019G5104 + KIT BAT

Aparafusadora de impacto HEXAGONAL 1/4" 18V.
0-2.800rpm. 0-3.600ipm. 160Nm. Luz Led. 1,37kg.
L-BOXX



361,00 €



C/2 Baterias
ProCORE 18V
4,0Ah

Aparafusadora de Impacto HEXAG 1/4"
GDR 18V-210C

06019J0102

Aparafusadora de impacto HEXAGONAL 1/4" 18V.
0-3.400rpm. 0-4.100ipm. 210Nm. 1,6kg. L-BOXX



419,00 €



C/2 Baterias
ProCORE 18V
4,0Ah



Chave de Impacto
GDS 18V-450 HC (Substitui GDS 18V-300)

06019K4003

18V. Motor S/ESCOVAS. CONNECTED.
HMI. 0-1000/1500/2300 RPM. M10-M20.
1/2". Quadrado Exterior. 450 Nm.
0-3.300 ipm. Inserção com anel retentor e furo de
fixação. Função ABR. Luz led e display digital. 1,6
kg. L-BOXX

450Nm

**FUNÇÃO ABR
(DESLIGA AUTOMÁTICO AO DESAPERTAR)**



**2 Baterias 18V
5,0Ah**

429,00 €

**MOTOR
S/ESCOVAS**

06019K4002

[C/2BAT 4.0Ah ProCORE + Cx.Cartão] - **459,00 €**



Chave de Impacto
GDX 18V-200

06019J2206

CHAVE IMPACTO Quadra 1/2" +
APARAFUSADORA IMPACTO Hexag 1/4".
Binário máx 200Nm, 3 escalões de binário.
Parafusos até M16. Em L-Boxx. Regulação de
velocidade.



APARAFUSADORA
DE IMPACTO GDR

CHAVE DE IMPACTO
GDS

APARAFUSADORA + CHAVE
IMPACTO GDX



C/2 Baterias 18V
4,0Ah

377,00 €

**MOTOR
S/ESCOVAS**



Chave de Impacto
GDX 18V-210C

06019J0203

CHAVE IMPACTO Quadra 1/2" +
Aparafusadora Impacto Hexag 1/4".
Binário máx 200Nm, 3 escalões de binário.
Parafusos até M16. Em L-Boxx.
Regulação de velocidade. CONNECTED. L-BOXX



APARAFUSADORA
DE IMPACTO GDR

CHAVE DE IMPACTO
GDS

APARAFUSADORA + CHAVE
IMPACTO GDX



C/2 Baterias
ProCORE 18V
4,0Ah

436,00 €

**MOTOR
S/ESCOVAS**

06019J0202

C/2 Bat 5.0Ah **419,00 €**



CHAVE DE IMPACTO QUADRA 1/2"
GDS 18V-1000

06019J8303

18V - BITURBO
1000Nm. M10-M24. 0-2.600 Bpm.
2.9Kg. 3 Níveis de velocidade
(0-800/1200/1750) Luz LED.
Display digital. Em L-Boxx

Binário de aperto 1000Nm
Binário de desapero (arranque) - 1600Nm

BITURBO
BRUSHLESS 



2 Baterias
18V 5,5Ah
ProCORE



587,00 €

06019J8302

(C/2 BAT 8.0Ah ProCORE) **639,00 €**

06019J8301

(S/Bat-S/Carr + L-BOXX) **335,00 €**



CHAVE DE IMPACTO QUADRA 1/2"
GDS 18V-1000C

06019J8003

18V - BITURBO
1000Nm. Connected. M10-M24. 0-2.600 Bpm. 2.9Kg.
3 Níveis de velocidade
(0-800/1200/1750) Luz LED. Display digital. Em
L-Boxx

Binário de aperto 1000Nm
Binário de desapero (arranque) - 1600Nm

BITURBO
BRUSHLESS  



2 Baterias
18V 5,5Ah
ProCORE



599,00 €

06019J8002

(C/2 BAT 8.0Ah ProCORE) **650,00 €**

06019J8001

(S/Bat-S/Carr + L-BOXX) **345,00 €**



Chave de Impacto Quadra 3/4"
GDS 18V-1050H

06019J8503

18V. BITURBO
1050Nm. M10-M24. 0-2.600 Bpm. 2.9Kg 3 Níveis de
velocidade
(0-800/1200/1750) Luz LED.
Display digital. Em L-Boxx

Binário de aperto 1050Nm
Binário de desapero (arranque) - 1700Nm

BITURBO
BRUSHLESS 



2 Baterias
18V 5,5Ah
ProCORE



597,00 €

06019J8502

(C/2 BAT 8.0Ah ProCORE) **650,00 €**

06019J8501

(S/Bat-S/Carr + L-BOXX) **335,00 €**



Chave de Impacto Quadra 3/4"
GDS 18V-1050HC

06019J8202

18V. BITURBO
1050Nm. Connected. M10-M24. 0-2.600 Bpm. 2.9Kg
3 Níveis de velocidade
(0-800/1200/1750) Luz LED.
Display digital. Em L-Boxx

Binário de aperto 1050Nm
Binário de desapero (arranque) - 1700Nm

BITURBO
BRUSHLESS  



2 Baterias
18V 8,0Ah
ProCORE



679,00 €

06019J8201

(S/Bat-S/Carr + L-BOXX) **345,00 €**



Martelo ELETRO-PNEUMÁTICO
GBH 18V-21

0611911102

18V. Energia de impacto 2,0j. 5.100ipm
Ø Máx. Perfuração em betão 21mm. 2,4kg.
Em L-Boxx.



MOTOR
S/ESCOVAS



C/2 Baterias 18V
4,0Ah



419,00 €

2 Uni - 406,00 €

0615990M9P (LOTE BOSCH 2932)

(C/2 Baterias 1x4.0Ah + 1x5.5Ah ProCORE) - 398,00 €



Martelo ELETRO-PNEUMÁTICO
GBH 18V-26D

0611916000+KIT BAT

18V. EMP. Energia de impacto: 2.5J. 4350ipm
ØPerfuração em betão: 26mm
Peso (S/bateria) : 2,6Kg



MOTOR
S/ESCOVAS



C/2 Baterias
ProCORE 18V
4,0Ah



508,00 €



Martelo ELETRO-PNEUMÁTICO
GBH 18V-26

0611909001 + KIT BATERIAS

18V. Energia de impacto 2,6J. 4.350ipm.
Ø Máx perfuração em betão 26mm.
Peso 2,6Kg
Em L-Boxx.



MOTOR
S/ESCOVAS



C/2 Baterias 18V
5,0Ah



550,00 €



Martelo Eletro Pneumático
GBH 18V-26 F

0611910007

18V, EMP
Energia de impacto: 2,6j. 4350ipm
Ø perfuração em betão: 26mm
Peso: 3,6kg
c/2 Bat. Lítio 18V de 5,0Ah em L-BOXX.
Pode acoplar dispositivo de aspiração



MOTOR
S/ESCOVAS



C/2 Baterias 18V
5,0Ah



576,00 €

061191000F

(C/2 BAT 5.5Ah ProCORE) - 639,00 €

061191000E

(C/2 BAT 8.0Ah ProCORE) - 671,00 €

0611910002

(C/2 BAT 6.0Ah) - 597,00 €



Bucha de substituição
rápida c/ brocas de
encadrouro cilíndrico.

OFERTA



Martelo BITURBO SDS-PLUS
GBH 18V-28DC

0611919000 + KIT BATERIAS

18V. EMP
Energia de impacto: 3,4J. 4250ipm
Ø Perfuração em betão : 28mm
Peso (S/bateria): 3Kg
Pode acoplar dispositivo de aspiração



C/2 Baterias 18V
5,0Ah

543,00 €



Martelo BITURBO SDS-PLUS
GBH 18V-34CF

0611914003

18V. BITURBO
Motor S/Escovas.CONNECTED. HMI. KickBack Control. EMP. Sistema Anti vibração. Função de cinzelar. 5,8 J. 2.900 ipm. SDS-plus. Ø Máx. perfuração em betão: 32 mm. 4,9 Kg. Luz LED. Arranque suave.
3 modos de operação.
Possibilidade de acoplar dispositivo de aspiração.
Mala

**PERFURAÇÃO EM BETÃO ATÉ
32MM**



2 Baterias
18V 5,5Ah
ProCORE



902,00 €

0611914002

(C/2 BAT 8.0Ah ProCORE)

944,00 €

0611914001

(S/Bat-S/Carr + Mala)

618,00 €



Martelo BITURBO SDS-MAX
GBH 18V-36C

0611915003

18V. BITURBO
Motor S/Escovas. CONNECTED. KickBack Control. EMP. Sistema Anti vibração. Função de cinzelar. 7,0 J. 2.900 ipm. SDS-Max.
Ø Máx. perfuração em betão: 35 mm.
5,1 Kg. Luz LED.
Possibilidade de acoplar dispositivo de aspiração.

**7.0J EQUIVALENTE A UM
MARTELO C/CABO DE 1.000W**

**PERFURAÇÃO EM BETÃO ATÉ
35MM**



2 Baterias
18V 5,5Ah
ProCORE



944,00 €

0611915002

(C/2 BAT 8.0Ah ProCORE)

1 017,00 €

0611915001

(S/Bat-S/Carr +Mala)

671,00 €



Martelo BITURBO SDS-MAX
GBH 18V-45C

0611913002

18V. BITURBO
Motor S/Escovas. CONNECTED. KickBack Control. EMP. Sistema antivibração. Função de cinzelar.
12,5 J. 2.720 ipm. SDS-Max.
Ø Máx. de perfuração em betão: 45 mm.
8,0 Kg. Luz LED.
Possibilidade de acoplar dispositivo de aspiração.

**12,5J EQUIVALENTE A UM
MARTELO C/CABO DE 1.800W**

**PERFURAÇÃO EM BETÃO ATÉ
45MM**



2 Baterias
18V 12Ah
ProCORE



1 406,00 €

0611913000

(S/Bat-S/Carr +Mala) -

996,00 €



MOTOR S/ESCOVAS

Mini-Rebarbadora GWS 18V-7 (115)

06019H9004 + KIT BAT

Mini-Rebarbadora GWS 18V-7 (125)

06019H9002 + KIT BAT

18V. 115 ou 125mm. 11.000rpm. Sistema ECP (Proteção Celular Eletrónica). 1,6kg. Em L-Boxx. (Potência equivalente a 700W de uma mini rebarbadora com cabo)



C/2 Baterias ProCORE 18V 4,0Ah



387,00 €

GWS 18V-7 (125)

06019H9005 (C/2Bat 4.0Ah)

338,00 €



MOTOR S/ESCOVAS

Mini-Rebarbadora GWS 18V -10 (115)

06019J4001 + KIT BAT

Mini-Rebarbadora GWS 18V -10 (125)

06019J4003 + KIT BAT

18V. 115 ou 125mm. 9.000rpm. Proteção contra re arranque. Sistema de travão inteligente. ,1kg. Em L-Boxx. (Potência equivalente a 1.000W de uma mini rebarbadora com cabo)



C/2 Baterias ProCORE 18V 4,0Ah



413,00 €

GWS 18V-10 (125)

06019J4007 (C/2Bat 4.0Ah)

381,00 €



BITURBO BRUSHLESS MOTOR S/ESCOVAS

Mini-Rebarbadora GWS 18V-15 C (125)

06019H6000 + KIT BAT

BITURBO. 18V. CONNECTED (conectividade com o smartphone via APP Toolbox). 125 mm. 11.000 rpm. KickBack Control. Drop control. Proteção contra re arranque. Sistema de travão inteligente. Punho auxiliar anti-vibração. 2,2 Kg. Porca SDS-CLick. (Potência equivalente a 1.500W de uma mini rebarbadora com cabo)



C/2 Baterias ProCORE 18V 5,5Ah



634,00 €

06019H6000 + KIT BAT

(KIT 2 Baterias 8,0Ah ProCore)

686,00 €

Velocidade variável



BITURBO BRUSHLESS MOTOR S/ESCOVAS

Mini-Rebarbadora GWS 18V-15 SC (125)

06019H6102

BITURBO. 18V. CONNECTED (conectividade com o smartphone via APP Toolbox). 125 mm. Regulação de velocidade 3.400 - 11.000 rpm. KickBack Control. Drop control. Proteção contra re arranque.Sistema de travão inteligente. Porca SDS click. Punho auxiliar anti-vibração. 2,3 Kg. (Potência equivalente a 1.500W de uma mini rebarbadora com cabo)



C/2 Baterias ProCORE 18V 5,5Ah



629,00 €

06019H6102

06019H6101

(C/2 Baterias 8,0Ah ProCore)

702,00 €



BITURBO BRUSHLESS MOTOR S/ESCOVAS

Rebarbadora GWS 18V-180 PC

06019H6E01 + KIT BAT ProCORE 8.0Ah

BITURBO. 18V. Motor S/Escovas. CONNECTED 180 mm. 7.000 rpm. KickBack Control. Drop control. Proteção contra re arranque. Sistema de travão inteligente. Punho auxiliar anti-vibração. Interruptor de segurança ("homem morto"). 2,8 Kg. Oferta: 1 Disco diamante (180mm) 2 de corte (180mm)



C/2 Baterias ProCORE 18V 8,0Ah

DISCO Ø180mm Capacidade de corte Igual a rebarbadora 230mm



675,00 €



Retificadora direita
GGS 18V-20

06019B5400 + KIT BAT

RETIFICADORA DIREITA. 18V.
Motor de 4 pólos. 22.000rpm.
Ø Máx. Pinça de aperto 6mm. Sistema ECP.
1,8kg em L-Boxx



C/2 Baterias
ProCORE 18V
4,0Ah



434,00 €



Retificadora direita
GGS 18V-23 LC

0601229100 + KIT BAT

RETIFICADORA DIREITA. 18V. CONNECTED.
23.000rpm. Ø Máx. Pinça de aperto 8mm. Sistema
ECP. KickBack Control. Arranque suave. Proteção
contra re arranque. Sistema de travão inteligente.
1,4kg. Em L-Boxx.



MOTOR
S/ESCOVAS



C/2 Baterias
ProCORE 18V
4,0Ah



497,00 €



Serra circular
GKS 18V-57 G

06016A2101+KIT BAT

SERRA CIRCULAR. 18V.
Profundidade de corte a 45°/90°: 42/57mm.
Ø Disco 165mm. 3.400rpm. 4,1kg. Em L-Boxx



C/2 Baterias
ProCORE 18V
4,0Ah



455,00 €



Multiferramenta
GOP 18V-28

06018B6001 + KIT BAT

MULTIFERRAMENTA. 18V. MOTOR EC. Sistema Sta-
clock. 8.000-20.000 Opm.
Ângulo de oscilção 2,8°. Substituição de acessórios
SDS. 1,35kg em L-Boxx



C/2 Baterias
ProCORE 18V
4,0Ah



462,00 €



Plaina
GH0 18V Li

06015A0300 + KIT BAT

PLAINA. 18V. Sistema Woodrazor. 82mm de largura
de trabalho da plaina. Ajuste de espessura de
rebaixo de 0-1,6mm. 2,6kg. Em L-Boxx



C/2 Baterias
ProCORE 18V
4,0Ah



450,00 €

Serra Sabre
GSA 18V-Li

060164J007 + KIT BAT

SERRA SABRE. 18V. COMPRIMENTO DO CURSO 28MM. 2.400-2.600CPM.



C/2 Baterias
ProCORE 18V
4,0Ah



434,00 €

Serra Sabre
GSA 18V-Li C

06016A5001 + KIT BAT

SERRA SABRE. 18V. Comprimento do curso 21mm. 0-3.050cpm. Luz Led. 2,5kg em L-Boxx



C/2 Baterias
ProCORE 18V
4,0Ah



403,00 €

Serra Vertical
GST 18V-Li B

06015A6101 + KIT BAT

SERRA VERTICAL. 18V. Regulação eletrónica. Profundidade corte até 120mm. 2.700cpm. Base ajustável a 45°. Substituição da lâmina de serra SDS. Movimento Pendular de 4 escalões. Travão de motor. Função de sopro. Sistema ECP. EMP. Luz Led. 2,4kg em L-Boxx



C/2 Baterias
ProCORE 18V
4,0Ah



455,00 €

Lixadora Vibratória
GSS 18V-10

06019D0202 + KIT BAT

LIXADORA VIBRATÓRIA. 18V. 22.000 Opm. Superfície de lixar de 115x107mm. Ø do círculo de oscilação 1,6mm. Sistema de fixação da folha de lixa por tensão e velcro. 0,88kg. Em L-Boxx



C/2 Baterias
ProCORE 18V
4,0Ah



407,00 €



Soprador
GBL 18V-120



06019F5100

SOPRADOR 18V. Caudal 120m³/h. Velocidade de sopro 75m/s. Peso 1,1kg (S/Bateria)

87,00 €

**S/Baterias
S/Carregador**

Pistola/Soprador Ar Quente
GHG 18V-50



06012A6501

18V. Dos níveis de temperatura (300/500 °C). Luz LED. Fluxo do ar max 175 l/min. Proteção contra reaquecimento. 0,59 Kg.

198,00 €

**S/Baterias
S/Carregador**

Pistola P/Aplicação Silicone
GCG 18V-600

06019C4001

PISTOLA P/APLICAÇÃO SILICONE. 18V. P/Cartuchos 400ml ou bolsas 600ml. Pressão 3,5kN. Força alimentação máx 9mm/seg. Ajuste velocidade 9 posições. Função auto-reverse. 2,2Kg



356,00 €

**S/Baterias
S/Carregador**



Aparafusadora pladur
GTB 18V-45

06019K7002

18V. Motor s/Escovas. Batente de profundidade retrátil. ØMáx de parafuso 6mm, 0-4.500 Rpm e 6.0Nm de binário máximo. Encaixe 1/4" interior. Em L-BOXX. (Ref antiga GSR 18V-EC TE)



C/2 Baterias
ProCORE 18V
4,0Ah

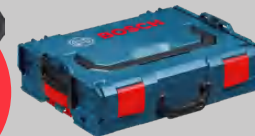

419,00 €

06019K7001

(S/Bat-S/Carr)

209,00 €



1600A025GD - GMA 55 (P/GTB)

Adaptador de alimentação automática RF **99,00 €**



Rebitadora
GRG 18V-16C

06019K5001

18V. Motor S/Escovas. Connected.16.000 N. Comprimento do curso 25 mm. Diâmetro de rebite cego:3,0/3,2; 4,0; 4,8/5,0 e 6,4 mm. Modos: Auto e Manual. 290 x 243 x 67 mm. 1,6 Kg.



C/2 Baterias
ProCORE 18V
4,0Ah

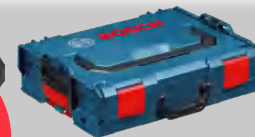

996,00 €



Pregadora
GNH 18V-64 M

0601481003

Pistola de pregos para acabamento. 18V. Diâmetro do prego 1,6 mm. Comprimento do prego 32-64 mm. Ângulo do carregador 20°. 337 x 262 x 97. Ajuste da profundidade. Fixação rápida e precisa c/2 modos de disparo: Simples e por contacto. 2,9 Kg.



C/2 Baterias
ProCORE 18V
4,0Ah

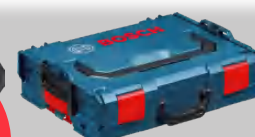

755,00 €

Aspirador
GAS 18V-1

06019C6200

ASPIRADOR P/SECO. 18V. 700ml. 60mbar. 1,3kg
Manuseamento ideal. Vasto leque de acessórios:
Tubo extensível. Bocal p/chão, bocal para cantos.
Tubo flexível.
Mobilidade e transporte fácil:
pode ser arrumado numa L-BOXX (não incluída)



104,00 €

S/Baterias
S/Carregador

Aspirador
GAS 18V-10L

06019C6302

ASPIRADOR P/SECO E HUMIDO. 18V. 10lt. 90mbar.
Filtro HEPA. 4,6kg (S/Bateria).
C/Mangueira alta qualidade. Tubo Curvo + 3 Tubos
Extensíveis. Boca P/Canto. Fita p/transportar.
4 Rodas Extensíveis.
Adaptador para ferramenta elétrica.



168,00 €

S/Baterias
S/Carregador

Lanterna
GLI 18V-1200 C

0601446700

LANTERNA 14,4V e/ou 18V.
12 LED. 1200 LUM.
2 tipos de intensidade.
Orientável em 5 posições.
Autonomia de 80min segundo a
bateria.1,4kg



104,00 €

S/Baterias
S/Carregador

Lanterna
GLI 18V-300

06014A1100

LANTERNA 14,4V e/ou 18V. 8 LED. 300 LUM.
Orientável em 5 posições.
Autonomia de 24 horas de iluminação.
0,3kg (S/Bateria)



62,00 €

S/Baterias
S/Carregador

C/1 Bateria 18V-4.0Ah + Carregador GAL 18V-40
(LOTE BOSCH 7032)
156,00 €

Lanterna
GLI 18V-1900

0601446400

LANTERNA 14,4V e/ou 18V.
LED de 1900 Lum.
Rosca de 5/8".
2 Níveis de intensidade.Orientável
em 5 posições. Autonomia até 8h
(segunda bateria). 1,6 Kg.



121,00 €

S/Baterias
S/Carregador

Lanterna
GLI 18V-2200 C

0601446501

CONNECTED (conectividade com o
smartphone via APP Toolbox). 1 LED
de 2200 Lum.Rosca de 5/8". IP 64.
2 Níveis de intensidade. Orientável
em 5 posições. Autonomia até 8h
(segunda bateria).1,9 Kg. Novo re-
flector oval.



156,00 €

S/Baterias
S/Carregador

Lanterna
GLI 18V-4000C

0601446800

18V. 1 LED. 4.000 Lum. CONNECTED.
3 Níveis de luminosidade:
4.000 / 2.000 / 1.000 Lm.
Autonomia 6 horas de iluminação
(com uma bateria ProCORE18V de
12,0Ah). Barras de proteção.
Possibilidade de acoplamento tripé
5/8". IP 20. Pega ajustável.



4000
LUMEN

230,00 €

S/Baterias
S/Carregador

Lanterna
GLI 18V-10000C

0601446900

18V. 1 LED. 10.000 Lum.
CONNECTED.
3 Níveis de luminosidade:
10.000 / 5.000 / 1.000 Lm.
Autonomia 2,5 horas de iluminação
(com uma bateria ProCORE18V de
12,0Ah). Barras de proteção.
Possibilidade de acoplamento tripé
5/8". IP 20. Pega ajustável.



10000
LUMEN

324,00 €

S/Baterias
S/Carregador



Berbequim c/Percussão
GSB 13 RE

0601217100

Berbequim c/ Percussão 600W, 13mm (Betão),
Reversível, Eletrónica.
Bucha de Aperto Rápido.

78,00 €

2 Uni - **73,00 €**



Berbequim c/Percussão
GSB 16 RE

060114E500

Berbequim c/ Percussão 750W, 16mm (Betão).
Reversível. Electrónico. Bucha de Aperto Rápido.



163,00 €



Berbequim c/Percussão
GSB 20-2

060117B400

Berbequim c/ Percussão 850W, 20mm (Betão),
2 Velocidades. Reversível. Electrónico. Bucha de
aperto rápido. Carcaça de engrenagen metálica.



198,00 €

2 Uni - **182,00 €**

BERBEQUINS C/PERCUSSÃO BERBEQUIM ANGULAR - MISTURADOR



Berbequim c/Percussão
GSB 24-2

060119C801

Berbequim c/ Percussão 1.100W, 22mm (Betão), 2 Velocidades. Reversível. Eletrónico. Caixa Engrenagens Metálica. Bucha Auto Lock.

230,00 €



Berbequim c/Percussão
GSB 21-2 RCT

060119C700

Berbequim c/ Percussão **1.300W**, 22mm (Betão), 2 Velocidades. Reversível.

Elevado binário (43/20,5Nm). Caixa Engrenagens Metálica. Anti Rotação. Bucha Auto Lock. KICK BACK CONTROL.

272,00 €



Berbequim angular S/PERCUSSÃO
GWB 10 RE

0601132703

400 W. Ø Perfuração aço: 10 mm. 1 Velocidade.

377,00 €



Misturador
GRW 18-2 E

06011A8000

1.800W. 2 Velocidades (0-450/1.050rpm). Rosca M14. Eletrónica constante. 7,2kg.

OFERTA
BARRA
MISTURADORA
Ø160mm

555,00 €



Berbequim s/ Percussão
GBM 6 RE

0601472600

350W. 4.000rpm. Ø perfuração Aço 6,5mm.
1 Velocidade, 1,2kg

110,00 €



Berbequim s/ Percussão
GBM 10 RE

0601473600

600W. 2.600rpm. Reversível. 10mm(Aço)

131,00 €



Berbequim s/ Percussão
GBM 1600 RE

06011B0000

BERBEQUIM S/ PERCUSSÃO
850W. 0-630rpm. Reversível.
Furação em Aço 16mm.

293,00 €



Berbequim s/ Percussão
GBM 13-2 RE

06011B2000

Berbequim S/Percussão. C/Bucha de aperto rápido
750W - 0-1000/3000rpm (2 Velocidades).
Furação em Aço 13mm. 2,4kg

293,00 €

06011B2002

Bucha precisão c/chave

303,00 €



Berbequim s/ Percussão
GBM 16-2 RE

0601120503

Berbequim S/Percussão. 1050W. 2 Velocidades.
Reversível. Furação em Aço 16mm.

734,00 €

COLUNA MAGNÉTICA C/BERBEQUIM
GBM 50-2

06011B4020

1200W. ØPerfuração Aço 50mm
2 Velocidades : 50-255/100-510
Indicador Laser. 14,7Kg



1 406,00 €

APARAFUSADORAS / CHAVES DE IMPACTO



Aparafusadora
GSR 6-45 TE

IDEAL PARA PLADUR

0601445100

APARAFUSADORA c/ Batente de Profundidade.
701W, 0-4500rpm, 12Nm.
Ø parafuso autoparf: 6,0mm.

205,00 €



Aparafusadora
GSR 6-25 TE

IDEAL PARA METAL

0601445000

APARAFUSADORA c/ Batente de Profundidade.
701W, 0-2500rpm, 20Nm.
Ø Parafuso autoparf: 6,0mm.

230,00 €



Chave de impacto
GDS 18 E

0601444000

CHAVE DE IMPACTO Quadra 1/2".
500W, 250Nm.
Reversível. Rotação nominal: 500-1.300rpm.
Ø do parafuso: M18.

629,00 €



Chave de impacto
GDS 30

0601435103

CHAVE DE IMPACTO Quadra 1". 920W.
1.000Nm. Reversível.
Rotação nominal: 860rpm.
Ø do parafuso: M30.

1 227,00 €

MINI-REBARBADORAS 115-125MM



BOSCH

Rebarbadora
GWS 700

0601394003

Rebarbadora 700W
Disco: 115mm | 11.000rpm



58,00 €

2 Uni - **55,70 €**

Rebarbadora
GWS 7-115

0601388106

Rebarbadora 720W
Disco: 115mm | 11.000rpm



64,00 €

Rebarbadora
GWS 750

0601394000

Rebarbadora 750W
Disco: 115/125mm | 11.000rpm



66,00 €

Rebarbadora
GWS 7-115 E

0601388203

Rebarbadora 720W
C/ Regulação eletrónica:
2.800 - 11.500 Rpm
Disco: 115mm



89,00 €

2 Uni - **84,00 €**

Rebarbadora
GWS 9-115 S

0601396103

Rebarbadora 900W
C/ Regulação eletrónica:
2.800 - 11.500 Rpm
Disco: 115mm



110,00 €

Rebarbadora
GWS 9-125 S

0601396104

Rebarbadora 900W
C/ Regulação eletrónica:
2.800 - 11.500 Rpm
Disco: 125mm



93,00 €

MINI-REBARBADORAS 115-125MM

Rebarbadora
GWS 880 125

060139600A

Rebarbadora 880W
Disco: 125mm | 11.000rpm

77,00 €



Rebarbadora
GWS 880 115

0601396008

Rebarbadora 880W
Disco: 115mm | 11.000rpm

72,00 €

Rebarbadora
GWS 1000-125

0601828800

Rebarbadora 1.000W
Disco: 125mm | 11.000rpm
Arranque suave



104,00 €

2 Uni - **99,50 €**

Rebarbadora
GWS 11-125

060179D003

Rebarbadora 1.100W
Disco: 125mm | 11.500rpm
Arranque suave



156,00 €

Rebarbadora
GWS 1400

0601824800

Rebarbadora 1.400W
Disco: 125mm | 11.000rpm



135,00 €

2 Uni - **130,70 €**

Rebarbadora
GWS 14-125

06017D0000

Rebarbadora (1.300W) 1.400W
Disco: 125mm | 11.500rpm
c/Proteção contra reaquecimento
Kick Back Control. (2,3kg)
2,2Kg



167,00 €

Rebarbadora
GWS 14-125 S

06017D0100

Rebarbadora 1.400W
Disco: 125mm
Regulação eletrónica: 2.800-11.500rpm
c/Proteção contra reaquecimento
Kick Back Control. 2,2Kg



184,00 €

MINI-REBARBADORAS 125MM



BOSCH

Rebarbadora
GWS 17-125

06017D0200

Rebarbadora 1.700W. Disco: 125mm
11.500rpm
c/Proteção contra re arranque
Kick Back Control. Arranque Suave. 2,4Kg



215,00 €

Rebarbadora
GWS 17-125 S

06017D0300

Rebarbadora 1.700W. Disco: 125mm
2.800 - 11.500rpm
c/Proteção contra re arranque
Kick Back Control. Arranque Suave. 2,4Kg



226,00 €

06017D0600 - GWS 17-150S

Ø150mm | 1.700W | 2.400/9700Rpm

251,00 €

Rebarbadora
GWS 17-125 S INOX

06017D0500

Rebarbadora 1.700W
Disco: 125mm Regulação eletrónica
1.900 - 7.800 Rpm.
c/Proteção contra re arranque
Kick Back Control Arranque Suave. 2,4Kg



P/ Trabalhos em INOX

251,00 €

Rebarbadora
GWS 19-125 CI

060179N002

Rebarbadora 1.900W-125mm
| 11.500rpm



240,00 €

060179R002 - GWS 19-150 CI

Ø150mm | 1.900W | 9700Rpm

261,00 €

Rebarbadora
GWS 19-125 CIE

060179P002

Rebarbadora 1.900W
Disco: 125mm
Velocidade variável: 2.800-11.500rpm
Kick Back Stop. 2,4kg.



247,00 €

Rebarbadora
GWS 19-125 CIST

060179S002

Rebarbadora 1.900W
Disco: 125mm | 7.800rpm
c/Proteção contra re arranque
Kick Back Stop. Arranque suave. 2,5kg

**ELEVADO
BINÁRIO**



268,00 €

REBARBADORAS - 2200W/2400W

Rebarbadora
GWS 22-180J

06018C0300

REBARBADORA 2.200W.
Disco 180mm.8.500rpm.
Arranque suave. Protecção contra
re-arranque. Interruptor Tri-Contol. 5,2Kg



146,00 €

Rebarbadora
GWS 2200 J - **06018F4000**

(GWS 22-230 J - 06018C1300)

REBARBADORA 2.200W.
Disco 230mm. 6.500rpm
Arranque suave. Protecção contra
re-arranque. Interruptor Tri-Contol. 5,2Kg



146,00 €

06018F4100 - GWS 2200P

Interruptor homem morto

155,00 €

Rebarbadora
GWS 24-180 JZ

06018C2300

REBARBADORA 2.400W.
Disco 180mm. 8.500rpm
Arranque suave. Protecção contra
re-arranque. Interruptor Tri-Contol.
Proteção contra pó cyclon tech. 5,5Kg



181,00 €

Rebarbadora
GWS 24-230 JZ

06018C3300

REBARBADORA 2.400W.
Disco 230mm.6.500Rpm
Arranque suave. Protecção contra
re-arranque. Interruptor Tri-Contol.
Proteção contra pó CYCLON TECH. 5.5Kg



181,00 €

2 Uni - 176,00 €

06018F4200 - GWS 2400J

Interruptor tri-control

179,00 €

Rebarbadora
GWS 24-230 P

06018C3100

REBARBADORA 2.400W.
Disco 230mm.6.500Rpm
Punho reto anti-vibração.
C/Interruptor de segurança (homem morto)
protection. 5,5Kg



“P” - Interruptor HOMEM MORTO
Interruptor sem encravamento
O operador tem que estar sempre
a primir o interruptor.

167,00 €

06018F4300 - GWS 2400P

Interruptor homem morto

179,00 €



REBARBADORA
GWS 24-180 LVi

0601892F00

REBARBADORA 2.400W
Disco: 180mm | 8.500rpm

251,00 €



REBARBADORA
GWS 24-230 LVi

0601893F00

REBARBADORA 2.400W
Disco: 230mm | 6.500rpm

251,00 €

MOTOR S/ESCOVAS e C/TRAVÃO DE 2.800W

Rebarbadora
GWS 30-180 B

06018G0000

REBARBADORA 2.800W.
Disco 180mm.8.500rpm.
5,7Kg



Interruptor Bloqueável

Kick Back Control, Travão, controlo vibração e um sistema melhorado de amortização das vibrações para maior proteção do utilizador



329,00 €

MOTOR S/ESCOVAS e C/TRAVÃO DE 2.800W

Rebarbadora
GWS 30-230 B

06018G1000

REBARBADORA 2.800W.
Disco 230mm.6.500rpm.
5,9Kg



Interruptor Bloqueável

Kick Back Control, Travão, controlo vibração e um sistema melhorado de amortização das vibrações para maior proteção do utilizador



329,00 €

MOTOR S/ESCOVAS e C/TRAVÃO DE 2.800W

Rebarbadora
GWS 30-180 PB

06018G0100

REBARBADORA 2.800W.
Disco 180mm.8.500rpm.
5,7Kg



Interruptor Protection. Homem morto.

Kick Back Control, Travão, controlo vibração e um sistema melhorado de amortização das vibrações para maior proteção do utilizador



329,00 €

MOTOR S/ESCOVAS e C/TRAVÃO DE 2.800W

Rebarbadora
GWS 30-230 PB

06018G1100

REBARBADORA 2.800W.
Disco 230mm.6.500rpm.
5,9Kg



Interruptor Protection. Homem morto.

Kick Back Control, Travão, controlo vibração e um sistema melhorado de amortização das vibrações para maior proteção do utilizador



329,00 €

Rebarbadora
GWX 750-115

06017C9000

750W
11.000Rpm
Disco: 115mm
Proteção contra re arranque. 2,1Kg



93,00 €

Rebarbadora
GWX 9-115 S (C/Mala)

06017B1000

900W
2.800 - 11.000Rpm
Regulação eletrónica
Disco: 115mm
Proteção contra re arranque. 2,1Kg



135,00 €

Rebarbadora
GWX 10-125

06017B3000

1000W
11.000Rpm
Disco: 125mm
Proteção contra re arranque. 2,2Kg



125,00 €

Rebarbadora
GWX 14-125

06017B7000

1400W
11.000Rpm
Disco: 125mm
Proteção contra re arranque. 2,3Kg



156,00 €

Rebarbadora
GWX 17-125

06017C3002

1.700w, 11.000rpm, disco 125mm, arranque suave, electrónica constante e anti-vibração. 2,5Kg



240,00 €

POLIDORA DE DISCO - SERRA DISCO ABRASIVO ESMERIS



BOSCH

Polidora de Disco
GPO 14 CE

0601389000

1.400W
Regulação Eletrónica
750-3000rpm - 2,5kg



240,00 €

Serra Disco Abrasivo
GCO 14-24J

0601B37200

2400 W. 3.800 rpm. Capacidade de corte (perfil retangular):
100 x 196 mm.
Ø Disco: 355 mm. 18 Kg.



293,00 €

ESMERIL
GBG 35-15

060127A300

ESMERIL - MÓ Ø150mm,
350W, 3000rpm



177,00 €

ESMERIL
GBG 60-20

060127A400

ESMERIL - MÓ Ø 200mm,
600W, 3000rpm



256,00 €

Retificadora Direita
GGS 5000 L

0601224100

500W
33.000rpm
1,4kg



125,00 €

Retificadora
GGS 28 C

0601220000

600W
28.000rpm
1,4kg

219,00 €



Retificadora
GGS 28 CE

0601220100

650W
10.000 - 28.000rpm
1,4kg

240,00 €

Retificadora Longa
GGS 28 LC

0601221000

650W
28.000rpm
1,6kg

303,00 €



Retificadora Longa
GGS 28 LCE

0601221100

650W
10.000-28.000rpm
1,6kg

314,00 €

Retificadora Direita
GGS 8 CE

0601222100

750W
2.500-8.000rpm
1,7kg



366,00 €

Retificadora Direita
GGS 8 SH

0601214300

1.800W
8.000rpm
1,4kg



C/Porca de aperto rápido SDS-CLICK

702,00 €

PACK'S REBARBADORAS



BOSCH



Rebarbadora
GWS 880 - 115

Rebarbadora
GWS 1000 - 125

LOTE BOSCH 2311

PVP ~~176 €~~
PROMO
171 €

Poupança
5€

PACK 2 REBARBADORAS



Rebarbadora
GWS 2200 J

Rebarbadora
GWS 880 - 115

LOTE BOSCH 2452

PVP ~~218 €~~
PROMO
209 €

Poupança
9€

PACK 2 REBARBADORAS



Rebarbadora
GWS 2200 J

Rebarbadora
GWS 750 - 115

Rebarbadora
GWS 1000 - 125

LOTE BOSCH 2661

PVP ~~316 €~~
PROMO
302 €

Poupança
14€

PACK 3 REBARBADORAS



Rebarbadora
GWS 24-230 JZ

Rebarbadora
GWS 880 - 115

LOTE BOSCH 2696

PVP ~~253 €~~
PROMO
248 €

Poupança
5€

PACK 2 REBARBADORAS

LIXADORA TETO-LIXADORA BETÃO MÁQUINA ABRIR ROÇOS - TAMPAS DE PROTEÇÃO

LIXADORA DE TETOS
GTR 55-225

06017D4000

550W. 225 mm. 340 -910 rpm. Expansível. Comprimento com 1 extensão de 1,7 m.
2 modos de sucção: teto e paredes. 4,1 Kg (sem extensões)
Incluí: Prato Lixa - Tubo extensão 1x600mm - Mala

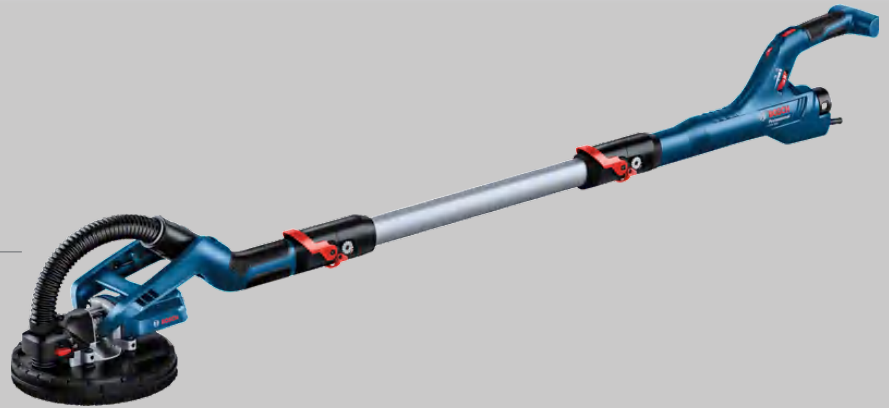

324,00 €

LIXADEIRA BETÃO
GBR 15 CAG

0601776001

1.500 W. 9.300 rpm. Rosca do veio: M14. Ø Mó: 125 mm. 2,6 Kg. Constant Electronic. Proteção contra reaquecimento. Arranque suave. Abertura frontal da cabeça para chegar aos cantos.



629,00 €

MÁQUINA ABRIR ROÇOS
GNF 65-A

0601368703

2.400W | Profundidade corte:20-65mm
Largura corte:3-40mm | ØDisco: 230mm
(FORNECIDO S/DISCOS)



1 017,00 €

Tampa de Proteção Corte
GDE 125 EA-S

1600A003DH

P/ Disco 125mm; Capacidade máx. de corte: 25mm.
Ajuste de profundidade

76,00 €



Tampa de Proteção Corte
GDE 230 FC-S

1600A003DL

P/ Disco 230mm; Capacidade máx. de corte: 60mm.
Ajuste de profundidade.

198,00 €



MARTELOS ELETRO PNEUMÁTICOS SDS-PLUS



BOSCH

MARTELO ELETRO-PNEUMÁTICO GBH 2-21

06112A6000

MARTELO ELETRO PNEUMÁTICO SDS-PLUS
720W. 2,2j. Perfuração até 21mm.
Eletrónico. Reversível.
Bloqueio de percussão p/ Cinzelar. 2,3kg



135,00 €

2 Uni - **130,00 €**

Martelo Eletro-Pneumático GBH 2-25

0611253500

MARTELO ELETRO PNEUMÁTICO SDS-PLUS
790W. 2,5j. Perfuração até 25mm.
Eletrónico. Reversível.
Bloqueio de Percussão p/ Cinzelar. 2,7kg



177,00 €

2 Uni - **171,00 €**

Martelo Eletro-Pneumático GBH 2-25 F

0611254600

MARTELO ELETRO PNEUMÁTICO SDS-PLUS
790W. 2,5j. Perfuração até 25mm.
Eletrónico. Reversível.
Bloqueio de Percussão p/ Cinzelar. 2,7kg



OFERTA

Bucha de substituição rápida p/ brocas de encabadoiro cilíndrico.

205,00 €

Martelo Eletro-Pneumático GBH 2-26

06112A3000

MARTELO ELETRO PNEUMÁTICO SDS-PLUS
830W. 2,7j. Perfuração até 26mm. Eletrónico. Reversível.
Bloqueio de Percussão p/ Cinzelar. Rótula no cabo. 2,7kg.



198,00 €

2 Uni - **192,00 €**

Martelo Eletro-Pneumático GBH 2-26 F

06112A4000

MARTELO ELETRO-PNEUMÁTICO SDS-PLUS
830W. 2,7j. Perfuração até 26mm. Eletrónico.
Reversível. Bloqueio de Percussão p/ Cinzelar, p/ furar
em madeira e aço. 2,9kg.



OFERTA

Bucha de substituição rápida p/brocas de encabadoiro cilíndrico.

240,00 €

2 Uni - **225,00 €**

MARTELOS ELETRO PNEUMÁTICOS E COMBINADOS SDS-PLUS

MARTELO ELETRO PNEUMÁTICO GBH 2-28 F

0611267600

MARTELO ELETRO PNEUMÁTICO SDS-PLUS
880W. 3,2j. Perfuração até 28mm. Eletrónico. Reversível.
Bloqueio de Percussão p/ Cinzelar. Sistema Anti-Vibração.
3,1kg



OFERTA



Bucha de substituição rápida p/ brocas de encabadouro cilíndrico.

303,00 €

2 Uni - **295,00 €**

MARTELO COMBINADO GBH 3000

061124A006

MARTELO COMBINADO SDS-PLUS
800W. 3,1j. Perfuração até 28mm., Eletrónico. Reversível.
Bloqueio de Percussão p/ Cinzelar - c/Bucha intercambiável
SDS-PLUS. 3,6kg



OFERTA



Bucha de substituição rápida p/brocas de encabadouro cilíndrico.

366,00 €

MARTELO COMBINADO GBH 3-28 DRE

061123A000

MARTELO COMBINADO SDS-PLUS
800W. 3,1j. Perfuração até 28mm. Eletrónico.
Bloqueio de Percussão p/ Cinzelar. 20% menos vibrações.
3,5kg



387,00 €

MARTELO COMBINADO GBH 4-32 DFR

0611332100

MARTELO COMBINADO SDS-PLUS
900W. 4,2j. Perfuração até 32mm. Eletrónico.
Bloqueio de percussão e sistema Anti-Vibração. 4,7kg



597,00 €

MARTELO COMBINADO GBH 4-32 DFR SET

0611332101

MARTELO COMBINADO SDS-PLUS
900W. 4,2j. Perfuração até 32mm. Eletrónico.
Bloqueio de percussão e sistema Anti-Vibração. 4,7kg.



OFERTA



Bucha de substituição rápida p/brocas de encabadouro cilíndrico.

618,00 €

MARTELOS COMBINADOS PERFURADORES/DEMOLIDORES SDS-MAX



BOSCH

MARTELO COMBINADO GBH 5-40 D

0611269001

MARTELO COMBINADO (Perfurador/Demolidor)
1.100W. 8,5j. Perfuração até 40mm.
Regulação de velocidade. Bloqueio Percussão p/ Cinzelar.
6,8kg



629,00 €

MARTELO COMBINADO GBH 5-40 DCE

0611264000

MARTELO COMBINADO (Perfurador/Demolidor)
1.150W. 8,8j. Perfuração até 40mm. Eletrónico.
Bloqueio de rotação p/ Cinzelar. 6,8Kg.



702,00 €

2 Uni - 682,00 €

MARTELO COMBINADO GBH 8-45 D

0611265100

MARTELO COMBINADO (Perfurador/Demolidor)
1.500W. 12,5j. Perfuração até 45mm. Eletrónico.
Bloqueio Percussão. 8,2kg.



891,00 €

MARTELO COMBINADO GBH 8-45 DV

0611265000

MARTELO COMBINADO (Perfurador/Demolidor)
1.500W. 12,5j - Perfuração até 48mm. Eletrónico.
Bloqueio Percussão. Novo sistema Anti Vibrações. 8,9kg



975,00 €

MARTELO COMBINADO GBH 12-52 DV

0611266000

MARTELO COMBINADO (Perfurador/Demolidor)
1.700W. 19j. Perfuração até 52mm. Eletrónico. Bloqueio
percussão. Sistema vario-lock com 12 possibilidades de
ajuste. Novo sistema anti-vibração. 11,9kg.



MARTELO COMBINADO GBH 12-52 D

0611266100

s/ sistema anti-vibração

1 101,00 €

1 206,00 €

MARTELOS DEMOLIDORES SDS-MAX

MARTELO DEMOLIDOR GSH 5

0611338700

MARTELO DEMOLIDOR
5,6Kg. 1.100W. 7,5j



450,00 €

MARTELO DEMOLIDOR GSH 5 CE

0611321000

MARTELO DEMOLIDOR
6kg. 1.150W. 8,3j. Eletrónico.
Amortecimento de Vibração.



629,00 €

MARTELO DEMOLIDOR GSH 7 VC

0611322000

MARTELO DEMOLIDOR
8kg. 1.500W. 13j. Eletrónico Constante.



IDEAL PARA TRABALHOS
DE CINZELAGEM NA
HORIZONTAL

828,00 €

MARTELO DEMOLIDOR GSH 11 E

0611316703

MARTELO DEMOLIDOR
10kg. 1.500W. 16,8j. Eletrónico.



620,00 €

2 Uni - 585,00 €

MARTELO DEMOLIDOR GSH 11 VC

0611336000

MARTELO DEMOLIDOR
11kg. 1.700W. 23j (Maior capacidade de arranque da sua
classe)



954,00 €

MARTELO DEMOLIDOR GSH 16-30

0611335100

MARTELO DEMOLIDOR
16kg. 1.750W. 41j. Eletrónico. **Inserção Hexagonal 30mm**



1 206,00 €



PLAINAS

PLAINA
GHO 26-82 D

06015A4301

710W
82mm de largura de lâmina
Espessura Aparas: 0-2,6mm
Profundidade Rebaixo: 0-9mm

209,00 €



PLAINA
GHO 16-82

06015A4000

630W
82mm de largura de lâmina
Espessura Aparas: 0-1,6mm
Profundidade Rebaixo: 0-9mm

173,00 €



PLAINA
GHO 40-82 C

060159A760

710W
82mm de largura de lâmina
Espessura Aparas: 0-4mm
Profundidade Rebaixo: 0-24mm

351,00 €



LIXADORA DE CINTA
GBS 75 AE SET

0601274707

750W
Largura Superfície: 75mm
Cinta: 533x75mm

335,00 €



LIXADORAS ROTO-ORBITAIS

GEX 125-1 AE

0601387500

250W
Prato lixa: 125mm
7.500 a 12.000rpm

141,00 €



GEX 40-150

060137B202

400W
Prato lixa: 150mm
5.500 a 12.000rpm

289,00 €



GET 75-150

0601257100

750W
Prato lixa: 150mm
3.300 a 7.300rpm
Arranque 3x Maior (turbo)
Constante Eletronic | Seleção de Velocidade.

461,00 €

0601257101

Em mala - **471,00 €**



GEX 34-150

0601372800

340W
Prato lixa: 150mm
4.500 a 12.000rpm

251,00 €

2 Uni - **247,00 €**



GSS140-1A

06012A2100

180W. Superfície de Trabalho:115x107mm
 Ø Oscil=1,6mm c/ Sistema Microfiltro.
 2 Sistemas fixação lixa (Velcro + Pinças)
 1,2Kg



125,00 €

GSS 23 AE

0601070701

190W. Superfície Trabalho: 92 x 182mm
 Ø Oscil=2,0mm c/ Sistema Microfiltro.
 2 Sistemas fixação lixa (Velcro + Pinças)
 7.000-12.000rpm



SL
167,00 €

Equipamento de série:
 Placa de lixa 1/4"
 Placa de lixa 1/6"
 Placa de lixa delta

GSS 160-1A MULTI

06012A2300

180 W. 12.000 r.p.m. Superfície de trabalho de 80 x 133 mm. Ø do círculo de oscilação: 1,6 mm. 1,2 Kg. Em L-BOXX 136



184,00 €

GSS 230 AVE

0601292802

300W
 Superfície de Trabalho: 92x182mm
 Ø Oscil=2,4mm
 8000 a 12000rpm. Eletrónica.



356,00 €

GSS 280 AVE

0601292902

350W
 Superfície de trabalho: 114x226mm
 Ø Oscil=2,4mm
 8000 a 12000rpm. Eletrónica.



377,00 €



SERRA CIRCULAR DE IMERSÃO GKT 55 GCE

0615990M9B

1.400W. Profundidade de corte 55mm.
[C/Bolsa FSN BAG + 2 Guias FSN1400 + Peça ligação (FSN
VEL) + Disco Serra Top Precision for wood 165-Z=48 + L-Boxx
374



Disco Pastilhado ProfPrecision
BS WOH 165x20-Z=48 - (2608642384)

67,00 €

IF



692,00 €

SERRA CIRCULAR DE IMERSÃO GKS 165

0601676100

Inovadora tecnologia dupla engrenagem. 1.100 W. Disco de
165 mm. 4.900 rpm. Capacidade de corte a 90°/45°: 66/47
mm. 3,6 kg.



173,00 €

SERRA CIRCULAR GKS 190

0601623000

1.400W. Disco 190mm
Corte 45°/90° = 50/70mm. 4,2kg



188,00 €

(Potência 1600W)

SERRA CIRCULAR GKS 65

0601667000

1.600W. Disco 190mm
Corte 45°/90° = 48/65mm. 4,8kg

261,00 €



(Potência 1900W)

SERRA CIRCULAR GKS 65 GCE

0601668900

1.900 W. Disco de 190 mm.
Corte: 45°/90°:48/65 mm. 4,9 Kg.

314 € 283 €

SL

SERRA CIRCULAR GKS 85

060157A000

2.200W. Disco 235mm
Corte 45°/90° = 65/85mm. 7,5kg



335,00 €

SERRAS MEIA ESQUADRIA

TELESCÓPICA

SERRA DE MEIA ESQUADRIA
GCM 800 SJ

0601B19000 **SL**

1.400W. Disco 216mm.
Capacidade de Corte 70x270mm. 13,5Kg

292,00 €

GCM 80 SJ

0601B19001

1.400W. Disco 216mm.
Capacidade de Corte 70x270mm. 13,5Kg

249,00 €



TELESCÓPICA

SERRA DE MEIA ESQUADRIA
GCM 8 SJL

0601B19100

1600W - Disco 216mm
Laser Integrado
Capacidade de corte 70x312mm - 17,3Kg

524,00 €



TELESCÓPICA

(IDEAL PARA ALUMÍNIO)

SERRA DE MEIA ESQUADRIA
GCM 12 SDE

0601B23100

1.800W. Disco 305mm. 28,4Kg
Capacidade de Corte: 120X200mm

996,00 €



SERRA DE MESA
GTS 635-216

0601B42001

1.600W. Disco 216mm. Mesa: 553x658x332
Altura corte 90°: 70mm. 22kg

(C/Mesa Trabalho GTA 560)

555,00 €

0601B42000

(S/Mesa Trabalho GTA 560)

492,00 €



SERRA DE MEIA ESQUADRIA
GCM 12 GDL

TELESCÓPICA

0601B23600

TELESCÓPICA de dupla oscilação
dta/esq. Inovador braço telescópico
patentado por Bosch para maior preci-
são. 2.000 W. 3.800 rpm.
Ø Disco: 305 mm.

Ajuste para cortes a : 52° Esq./60° Dir.
Ajuste do ângulo de inclinação: 47°
Esq./47° Dir.

Capacidade de corte: 104x341mm
32 Kg.

TELESCÓPICA
(IDEAL PARA MADEIRA)



1 154,00 €

SERRA DE MEIA ESQUADRIA
GCM 10 GDJ

TELESCÓPICA

0601B27000

TELESCÓPICA. 1.800 W. 4.800 rpm.
Ø Disco: 254 mm.

Ajuste para cortes para bisel:
52° Esq./60° Dta. Ajuste do ângulo de
inclinação: 48° Esq.

Capacidade de corte: 100 mm x 306 mm.
30,9 Kg.

TELESCÓPICA
(IDEAL PARA MADEIRA)



891,00 €

SERRA DE MEIA ESQUADRIA
GTM 12 JL

0615990EU2

1.800W. Disco 305mm. 23kg
Capacidade de Corte: 95x151mm
Capacidade de Corte Mesa Superior: 51mm



BANCADA
GTA 2600

723,00 €

2 Uni - **698,00 €**



TUPIA
GKF 600

060160A100

600W
Fresas 6 e 8mm. 1,5kg



219,00 €

TUPIA
GOF 1250 CE

0601626000

1.250W
Fresas 6 e 8mm. 3,6kg
Eletrónica Constante.
Ajuste Fino de profundidade



440,00 €

SERRA P/ESPUMA
GSG 300

0601575103

350W
Profundidade de corte: 300mm
(em goma espuma)

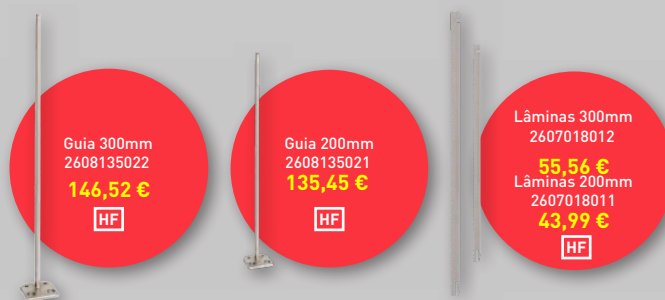

Guia 300mm
2608135022

146,52 €

HF

Guia 200mm
2608135021

135,45 €

HF

Lâminas 300mm
2607018012

55,56 €

Lâminas 200mm
2607018011

43,99 €

HF

639,00 €

(só serra GSG 300)

SERRAS SABRE - MULTIFERRAMENTAS

SERRA DE SABRE GSA 1100 E

060164C800

1.100W - 0-2.700cpm
Comprimento do curso 28mm.
Luz LED. 3,6kg



188,00 €

SERRA DE SABRE GSA 1300 PCE

060164E200

1.300W - 0-2.900cpm
Comprimento do curso 28mm.
Luz LED. 4,1kg



272,00 €

MULTIFERRAMENTA GOP 30-28

0601237001

300W. 8.000/20.000 Opm
Ângulo Oscilação: 2.8°. 1,5kg



OFERTA
1 Lâmina Segmentada
AIZ 32 APB

151,00 €

MULTIFERRAMENTA GOP 40-30

0601231000

400W. 8.000/20.000 Opm
Ângulo Oscilação: 3°. 1,5kg



OFERTA
1 Lâmina Segmentada
AIZ 32 APB

205,00 €

MULTIFERRAMENTA GOP 55-36

0601231100

550W. 8.000/20.000 Opm
Ângulo Oscilação: 3.6°. 1,6kg



OFERTA
1 Lâmina Segmentada
AIZ 32 APB

272,00 €

SERRAS VERTICAIS (TICO-TICO), TESOURAS E ROEDORAS



BOSCH

SERRA VERTICAL (TICO-TICO)
GST 8000 E

060158H000

710W
Profundidade de corte: 80mm



114,00 €

SERRA VERTICAL (TICO-TICO)
GST 90 BE

060158F000

650W
Profundidade de corte: 90mm



156,00 €

2 Uni - **151,00 €**

SERRA VERTICAL (TICO-TICO)
GST 150 BCE

0601513000

780W
Profundidade de corte: 150mm



230,00 €

SERRA VERTICAL (TICO-TICO)
GST 160 BCE

0601518000

800W
Profundidade de corte: 160mm



314,00 €

ROEDORA
GNA 2.0

0601530103

500W
Capacidade de Corte: Aço 2mm
2kg



660,00 €

TESOURA CORTA CHAPA
GSC 75-16

0601500500

750W
Capacidade de Corte: Aço 1,6mm
1,8kg



394,00 €

TESOURA CORTA CHAPA
GSC 2.8

0601506103

500W
Capacidade de Corte: Aço 2,8mm
2,7kg



870,00 €

PISTOLA DE COLAR, PISTOLAS DE AR QUENTE

PISTOLA DE COLAR GKP 200 CE

0601950703

500W. Capacidade de colagem:
30gr/min.
Para cola de Ø 0.11mm x 200mm.



135,00 €

PISTOLA /SOPRADOR AR QUENTE GHG 18V-50 (SEM FIOS)

06012A6501

18V. Dois níveis de temperatura (300/500°C)
Luz Led. Caudal Max ar 175Lt/min
Proteção contra reaquecimento. 0,59Kg



**S/Baterias
S/Carregador**

198,00 €

PISTOLA DE AR QUENTE GHG 20-63

06012A6201

2.000W. 50°C a 630°C. Ecrã LCD.
Ajuste de temperatura c/3 escalas.
Fluxo ar. Proteção térmica. Mala. 0,65kg



EXTRA
Bocal proteção
superfície vidro
75mm
+
Bocal superfície
50mm



156,00 €

06012A6200

Caixa de cartão **146,00 €**

PISTOLA DE AR QUENTE GHG 23-66

06012A6300

2.300W. 50°C a 660°C. Ecrã LCD.
Ajuste de temperatura c/10 escalas.
Fluxo ar. Proteção térmica. Mala. 0,65kg



EXTRA
Bocal proteção
superfície vidro
75mm
+
Bocal superfície
50mm



177,00 €

PISTOLA DE AR QUENTE GHG 20-60

06012A6400

2.000W
100°C a 600°C. Ajuste de temperatura c/2
escalas fluxo ar. Ideal para trabalhar em
locais estreitos. 0,55kg

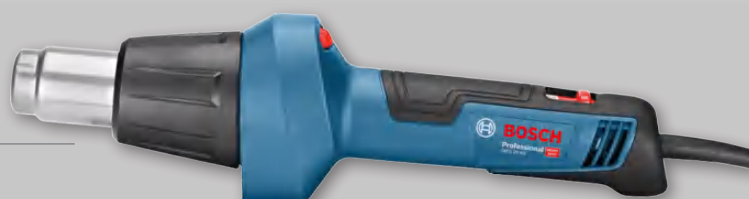

165,00 €



15Lt

ASPIRADOR
GAS 20 L SFC

060197B100

1.200W. Potência de sucção. 15lt.
Ligação sincronizada c/ ferramentas até
2.000W. Função sopra.

Limpeza de filtro semi-automática.

215mbar de pressão máxima.
Para seco/húmido.

251,00 €



25Lt

ASPIRADOR
GAS 25 L SFC

0601979103

1.200W Potência de sucção.
25lt. Ligação sincronizada c/ ferramentas
até 2.000W. Função sopra.

Limpeza de filtro semi-automática.

248mbar de pressão máxima.
Para seco/húmido.

440,00 €



35Lt

ASPIRADOR
GAS 35 L SFC +

06019C3000

1.380W. Potência de sucção.
35lt. Ligação sincronizada c/ ferramentas
até 2.200W. Função sopra.

Limpeza de filtro semi-automática.

Classe de filtro L.
254mbar de pressão máxima.
11,6Kg

576,00 €



35Lt

ASPIRADOR
GAS 35 L AFC

06019C3200

1.380 W potência de sucção. Para seco e
húmido. 35 L. Conexão sincronizada
com ferramentas até 2.200 W.

Limpeza de filtro semi-automática.

Equipamento e tubos anti-estático.
Classe de filtro L. Filtro de poliéster.
Filtro de poliéster. 254 mbar. 12,2 Kg.

671,00 €



35Lt

ASPIRADOR
GAS 35 M AFC

06019C3100

1.380 W potência de sucção. Para seco e
húmido. 35 L. Conexão sincronizada
com ferramentas até 2.200 W.

Limpeza de filtro automática.

Equipamento e tubos anti-estático.
Classe de filtro M. Filtro de poliéster.
254 mbar. 12,4 Kg.

797,00 €



55Lt

ASPIRADOR
GAS 55 M AFC

06019C3300

1.380 W potência de sucção. Para seco
e húmido. 55 L. Conexão sincronizada
com ferramentas até 2.200 W.

Limpeza de filtro automática.

Equipamento e tubos anti-estático.
Classe de filtro M. Filtro de poliéster.
254 mbar. 16,2 Kg.

996,00 €



DETETOR DIGITAL, CÂMARAS DE INSPEÇÃO E TOPÓMETRO

DETETOR DIGITAL GMS 120

0601081000

Até 12cm. Auto calibração e auto-zoom.
Deteta metais ferrosos, não ferrosos e cabos eléctricos com e sem tensão.
Orifício de marcação c/ luz LED de 3 cores.



118,00 €

DETETOR DIGITAL DTECT 200C

0601081600

Deteta ferro, cobre condutores eléctricos (C/ ou S/corrente, tubos (C/ ou S/Água), subestruturas em madeira.
Profundidade deteção máxima betão seco: 200mm (em betão fresco 60mm). Profundidade máxima de deteção noutros tipos de parede: 80mm



809,00 €

CÂMERA DIGITAL DE INSPEÇÃO GIC 120

0601241100

Ecrã a cores de 2,7" (7cm). Luz LED.
Função zoom. Ø Câmara 8,5mm.
Cabo c/ 120cm



258,00 €

TOPÓMETRO TELESCÓPICO GWM 32

0601074000

C/ pega curva. Diâmetro da roda 32cm.
Contador até 10km.

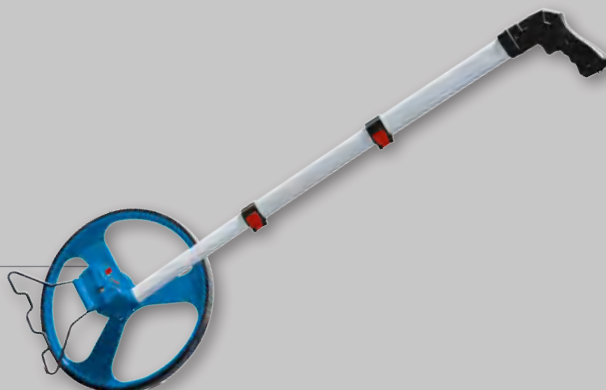

88,00 €



NÍVEL DIGITAL GIM 60

0601076700

De 600mm, Medição: 4x90°.
Função de memória. IP54.

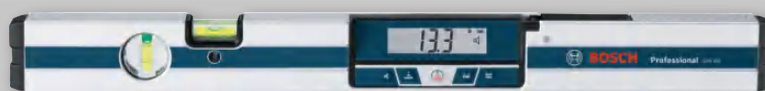

164,00 €

NÍVEL DIGITAL GIM 120

0601076800

De 1200mm, Medição: 4x90°.
Função de memória. IP54.

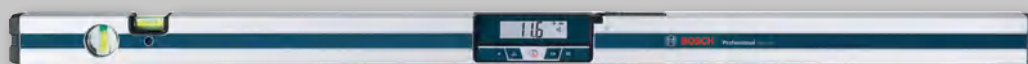

219,00 €

MEDIDOR DE ÂNGULOS DIGITAL GAM 220

0601076500

Medição: 0-220°. IP54.
Comprimento 40cm. Precisão 0.1°.
Função de memória. 2 bolhas de nível.



198,00 €

MEDIDOR DE ÂNGULOS DIGITAL GAM 220 MF

0601076600

Medição: 0-220°, precisão 0.1°. Comprimento 0-40cm, cálculo de ângulos para meia esquadria e bisel **c/ Prolongador Lateral**. IP54.



Prolongador lateral

219,00 €

MEDIDORES LASER DE DISTÂNCIAS (C/ CERTIFICADO DE FABRICAÇÃO)

MEDIDOR LASER DE DISTÂNCIAS GLM 40 PROFESSIONAL

0601072900

Até 40m c/ Precisão de +- 1,5mm
(c/ Medição contínua, soma e subtração)
(Pitágoras, Área, Volumes,
Memória c/ 10 registos). 2 Pilhas 1.5V



INCLUI
Bolsa

103,00 €

2 Uni - **99,00 €**

MEDIDOR LASER DE DISTÂNCIAS GLM 50-22

0601072500

Até 50m c/ Precisão de +- 1,5mm
Área, Volumes, Memória c/ 30 registos).
Peso:200gr. Ideal p/estaleiro de obras difí-
ceis.Certificação IP65. Carcaça amortece-
dora de choques e resistente a quedas de
1,5m módulo de números grandes
p/melhor leitura. 2 Pilhas 1.5V



INCLUI
Bolsa

161,00 €

2 Uni - **154,00 €**

LINHA VERDE

MEDIDOR LASER DE DISTÂNCIAS GLM 50-25 G

0601072V00

Até 50m c/ Precisão de +- 1,5mm
Área, Volumes, Memória c/ 30 registos).
Peso:200gr.IP65
Aviso da medição correta por vibração
2 Pilhas 1.5V



INCLUI
Bolsa

194,00 €

MEDIDOR LASER DE DISTÂNCIAS GLM 50-27 C

0601072T00

Até 50m c/precisão de +- 1,5mm
c/ Inclinómetro digital, medição contínua,
soma e subtração transferência de dados
via bluetooth ou micro USB p/ smartpho-
nes, tablets ou PC's) (Pitágoras,
Memoria 30 registos).IP65. 2 Pilhas 1.5V



INCLUI
Bolsa

222,00 €

MEDIDORES LASER DE DISTÂNCIAS (C/CERTIFICAÇÃO DE FÁBRICA)



BOSCH

LINHA VERDE

MEDIDOR LASER DE DISTÂNCIAS GLM 50-27 CG

0601072U00

Até 50m c/precisão de +- 1,5mm
c/ Inclinómetro digital, medição contínua,
soma e subtração transferência de dados
via bluetooth ou micro USB p/ smartpho-
nes, tablets ou PC's) (Pitágoras,
Memória 30 registos).
Iluminação e giro do ecrã



INCLUI
Bolsa

255,00 €

MEDIDOR LASER DE DISTÂNCIAS GLM 100-25 C

0601072Y00

Alcance: 100 m. Inclinómetro digital. Soma,
subtração, medição contínua, múltiples áreas,
mediciones indirectas, etc. Iluminação do
display. Memória (50 registos). Certificado ISO.
Transferência dos dados via Bluetooth ou micro
USB a Smartphones, tablets ou PC.

Bateria lítio e carregador. 3 Pilhas 1,5V (AA)

**GRANDE ECRÃ C/ CÂMARA DE 5MPX
PARA VER O ALVO DO LASER**



286,00 €

MEDIDOR LASER DE DISTÂNCIAS GLM 120 C PROFESSIONAL

0601072F00

Alcance até 120m
(c/ Medição contínua, soma e subtração)
(Pitágoras, Área, Volumes, Memória c/ 50 registos)
Transferência dos dados via Bluetooth ou micro USB
a Smartphones, tablets ou PC.

Bateria lítio e carregador. 3 Pilhas 1,5V (AA)

**GRANDE ECRÃ C/ CÂMARA DE 5MPX PARA
VER O ALVO DO LASER**



INCLUI
Bolsa

SL

289,00 €

MEDIDOR LASER DE DISTÂNCIAS GLM 150-27 C PROFESSIONAL

0601072Z00

Alcance até 150m
(c/ Medição contínua, soma e subtração)
(Pitágoras, Área, Volumes, Memória c/ 50 registos)
Transferência dos dados via Bluetooth ou micro USB
a Smartphones, tablets ou PC.

Bateria lítio e carregador. 3 Pilhas 1,5V (AA)

**GRANDE ECRÃ C/ CÂMARA DE 5MPX PARA
VER O ALVO DO LASER**



INCLUI
Bolsa

366,00 €

BASE
GIRATÓRIA



RM1

SUPORE
PAREDE E TETO



BM3



NÍVEL LASER PROJEÇÃO CRUZADA GCL 2-15

Projeção cruzada. Ampla projeção da linha vertical. Prumada acima e abaixo. Precisão: +/-0,3mm/m. Alcance: 15m. Alcance prumada: 10m. IP 54. Bloqueio de pêndulo. Compatível c/3 pilhas alcalinas 1,5V (AA)

0601066E00

(+RM1) **172,00 €**

0601066E02

(+RM1 + BM3 + MALA) **238,00 €**



SUPORE
MAGNÉTICO
LB10



TRIPÉ
BT150

LASER LINHA VERDE

NÍVEL LASER PROJEÇÃO CRUZADA VERDE GLL 2-15 G

Projeção cruzada. Ampla projeção da linha vertical. Prumada acima e abaixo. Precisão: +/-0,3mm/m. Alcance: 15m. Alcance prumada: 10m. IP 54. Bloqueio de pêndulo. Compatível c/3 pilhas alcalinas 1,5V (AA)



0601063W00

(+LB10) **199,00 €**

0601063W01

(+LB10+BT150) **246,00 €**

0601063W02

(+LB10+Pinça tectos+Mala) **263,00 €**

BASE
GIRATÓRIA



RM2

TRIPÉ



BT150

NÍVEL LASER PROJEÇÃO CRUZADA GCL 2-50 C

Nível Laser de Projeção cruzada (2 linhas). Precisão +/- 0.3mm/m. Alcance 20m s/ receptor e 50m c/ receptor. Com conectividade bluetooth. Compatível c/4 pilhas 1,5(AA) modelos 0601066G00 e 0601066G02 ou bateria Li 12V-2.0Ah+Carregador modelos 0601066G03(incluída) e 0601066G08 (S/Bat-S/Carr)



0601066G00

4 Pilhas AA (+RM 2) **285,00 €**

0601066G02

4 Pilhas AA(+ RM2 + BT150) **332,00 €**

0601066G03

BAT 12V-2.0Ah (+RM2) **366,00 €**

0601066G08

S/BAT-S/CARR (+RM2+BM3+L-BOXX) **323,00 €**

LASER LINHA VERDE

NÍVEL LASER PROJEÇÃO CRUZADA VERDE GCL 2-50 G

Nível Laser de Projecção cruzada (2 linhas). Precisão +- 0.3mm/m. Alcance 20m s/ receptor e 50m c/ receptor. Compatível c/ 4 pilhas 1,5V (AA)



0601066M00

(+ RM 10) **285,00 €**

0601066M02

(+ RM10 + Suporte teto+Mala) **349,00 €**

BASE GIRATÓRIA



RM2

LASER LINHA VERDE

NÍVEL LASER PROJEÇÃO CRUZADA VERDE GCL 2-50 CG

Nível Laser de Projecção cruzada (2 linhas). Precisão +- 0.3mm/m. Alcance 20m s/ receptor e 50m c/ receptor. Com conectividade bluetooth Modelo 0601066H00 c/bateria 12V-2.0Ah e carregador incluídos e o modelo 0601066H03 s/bateria e s/ carregador



0601066H00

BAT 12V-2.0Ah (+ RM2+ L-BOXX) **533,00 €**

0601066H03

S/BAT-S/CARR (+RM2+L-BOXX) **490,00 €**

RECETOR



LR2

SUPORTE PAREDE E TETO



BM1

NÍVEL LASER 3 PLANOS GLL 3-50 P

Nível Laser 3 Planos 360° (1 Hor+2Vert) prumada acima e abaixo. Alcance s/ receptor 10m, c/ receptor de 50m. Precisão 0.3mm/m. Compatível c/4 pilhas 1,5V (AA)



0601063800

339,00 €

0601063802

(+ BM1 + L-BOXX) **398,00 €**

0601063803

(+BM1+LR2+L-BOXX) **496,00 €**



TRIPÉ
BT150

NÍVEL LASER 3 PLANOS GLL 3-80

Nível Laser 3 Planos 360°
(1 Horizontal + 2 Verticais)
e 6 pontos de referência.
Alcance s/ recetor 30m, c/ recetor de 120m.
(C/4 Pilhas 1.5V LR6/AA)



| | | |
|------------|---|-----------------|
| 0601063S00 | (S/Acessórios - C/Mala) | 447,00 € |
| 06159940KD | +BT150+MALA | 460,00 € |
| 0601063R02 | (+BM1+Bat 12V+Carreg+L-Boxx) (Dupla fonte de potência) | 629,00 € |

LASER LINHA VERDE

NÍVEL LASER 3 PLANOS GLL 3-80 G

0601063Y00

Nível Laser 3 Planos 360°
(1 Horizontal + 2 Verticais)
e 6 pontos de referência.
Alcance s/ recetor 30m, c/ recetor de 120m.
(Mala)
(C/4 Pilhas 1.5V LR6/AA)

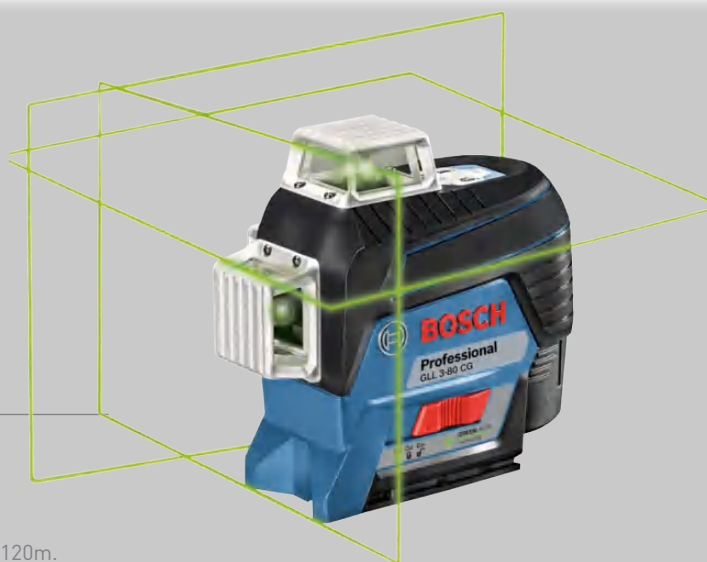

614,00 €

SUPORTE
PAREDE E TETO



BM1

LASER LINHA VERDE

NÍVEL LASER 3 PLANOS GLL 3-80 CG

0601063T00

Nível Laser 3 Planos 360°
(1 Horizontal + 2 Verticais)
e 6 pontos de referência.
Alcance s/ recetor 30m, c/ recetor de 120m.
C/ bateria de 12V + Carregador (incluídas)
C/L-BOXX
C/ Conetividade Bluetooth



796,00 €

2 Uni - **761,00 €**

NÍVEIS LASER ROTATIVOS E NÍVEIS ÓPTICOS



BOSCH



LR1 RC1 WM4

NÍVEL LASER GIRATÓRIO 300 METROS GRL 300 HV+RC1+WM4+LR1+BT170HD+GR 240

061599405U

Nível Laser Giratório c/ Auto nivelção Horizontal e Vertical
Alcance (Ø) 300m c/ Recetor
C/ Telecomando RC1 + Suporte WM4 + Recetor LR1 + Tripé BT 170HD + Régua Graduada GR 240. C/Mala Compatível c/1 pilha 1.5V LR6 (AA) + 1Pilha 9V (6LR61) + 2 Pilhas 1.5V LR20 (D). (Pilhas incluídas)



BT170HD



GR240



971,00 €

2 Uni - 929,00 €

LASER LINHA VERDE

NÍVEL LASER GIRATÓRIO LINHA VERDE 300 METROS GRL 300 HVG + RC1 + WM4 + LR1G + BT300 + GR 240

061599404B

Nível Laser Giratório c/ Auto nivelção horizontal e vertical.
Alcance (Ø) 300m c/ Recetor
C/ Telecomando RC1 + Suporte WM4 + Recetor LR1G + Tripé BT300 + Régua Graduada GR 240. C/Mala Compatível c/1 pilha 1.5V LR6 (AA) + 1Pilha 9V (6LR61) + 2 Pilhas 1.5V LR20 (D). (Pilhas incluídas)

4X
MAIS VISÍVEL
OLHO HUMANO



BT300



LR1G



GR240



RC1



WM4



1 244,00 €

MELHOR QUE A LINHA VERMELHA ATÉ 300m

0601061701 - GRL 300 HVG

RC1(Telecomando) + WM4(Suporte)+LR1G (Receptor) 924,00 €



NÍVEL ÓTICO GOL 26 D + BT 160 + GR 500

0601068002

Ampliação 26x. Precisão: 1,6mm a 30m.
Precisão angular: 1 grau (D).
Abertura da objetiva: 36mm. Alcance: 100m.
Peso: 1,7kg. [c/ Tripé BT160 + Régua GR 500]

339,00 €



GR500

BT160

NÍVEL ÓTICO GOL 32 D + BT 160 + GR 500

0601068502

Ampliação 32x. Precisão: 1,6mm a 30m.
Precisão angular: 1 grau (D).
Abertura da objetiva: 36mm. Alcance: 120m.
Peso: 1,7kg. [c/ Tripé BT160 + Régua GR 500]

371,00 €

BERBEQUIM
EASY IMPACT 600

0603133000

600W
c/ MALA, Eletrónico, Reversível, bucha de 13mm, 1,5kg



64,00 €

BERBEQUIM
EASY IMPACT 630

0603133100

630W
c/ MALA, Eletrónico, Reversível, bucha de 13mm, 1,6kg



71,00 €

BERBEQUIM
UNIVERSAL IMPACT 700

0603131000

700W
c/ MALA, Reversível, bucha de 13mm, 1,7kg



92,00 €

MARTELO ELÉTRO PNEUMÁTICO
PBH 2100

06033A9300

550W
c/ MALA, 1,7j, Reversível, bucha SDS-PLUS. Perfuração em betão 20mm. 2,2Kg



113,00 €

IXO BÁSICO

06039A8000

Tensão: 3,6V
Duração da carga: 5h



C/ SET 10 BITS + CARREGADOR + CAIXA

59,00 €

REBARBADORA
PWS 700-115

06033A240A

700W
11.000rpm, 2,2kg



59,00 €

SERRA TICO-TICO
PST 650

06033A0700

500W (PST 650) - c/ MALA
Profundidade de corte em madeira/aço:
65/4mm, N.º de cursos em vazio: 3.100cpm.



65,00 €

SERRA SABRE
PSA 700E

06033A7000

700W
Profundidade de corte madeira/aço: 150/10mm
Velocidade variável



106,00 €

SERRA CIRCULAR
PKS 55

0603500000

1.200W
Profundidade de corte: 55mm
Disco Ø: 160mm



106,00 €

SERRA CIRCULAR
PKS 40

06033C5000

600W
Profundidade de corte: 40mm
Disco Ø: 130mm



94,00 €

Lixadeira Vibratória Retangular
PSS 200 AC

0603340100

200W - 24.000 opm
Base 92x182mm



64,00 €

Lixadeira Vibratória Retangular
PSS 250 AE

0603340200

250W - 14.000/24.000 opm
Base 92x182mm



94,00 €

ASPIRADOR UNIVERSAL
VAC 15

06033D1100

1.000W
Capacidade de depósito: 15L
Potência nominal: 1.000W
Potência aspiração: 250W
Vaco máximo: 240mbar
Fluxo máximo de ar: 65Lt/s



P/Sólidos e líquidos

C/Acessórios

114,00 €

PISTOLA PINTAR
PFS 1000

0603207000

410W
Caudal: 0-100
Depósito: 800ml
Mangueira: 1,3m
Aplicação tinta: 1m²



90,00 €

Lixadeira Múltipla
PEB 500 E

-

500W
3.000/10.000rpm



93,00 €

Lixadeira de cinta
PBS 75 A

06032A1000

710W
Cinta 76X165mm



130,00 €

Agrafador
PTK 14 EDT

0603265500

Impactos: 30i.p.m.
220V
Agrafos Tipo 53 (11,4mm)
de 6 - 14mm; Pregos: 14mm



110,00 €

Agrafador
PTK 3.6 Li

0603968200

Impactos: 30i.p.m.
3,6V
Agrafos Tipo 53 (11,4mm)
de 4 - 10mm



75,00 €

Pistola de Ar Quente
EASYHEAT 500

06032A6000

1.600W
C/ Regulação do caudal de ar. (240/450lt/min)
Temperatura: 300/500°C



57,00 €

Pistola de Ar Quente
UNIVERSALHEAT 600

06032A6101

1.800W
C/ Regulação do caudal de ar.
(200/350/500lt/min)
Temperatura: 50/300/600°C



70,00 €

Pistola de Colar
GLUE PEN

06032A2000

Lápis de colar
c/ bateria lítio 3,6V;
Para cola Termo fusível



46,00 €

Pistola de Colar
PKP 18 E

0603264503

Capacidade: 20g/min;
Cola de fusão: 200mm



36,00 €

Medidor Laser
PLR 30 C

0603672100

Amplitude de medição:
0,05 - 30,00m; Precisão: 2,0mm



84,00 €

Detector Digital
PDO MULTI (UniversalDetect)

0603681300

Profundidade medição-aço/cobre/condutores
elétricos/madeira: 100/80/50/25mm
Calibração automática



101,00 €

Detector Humidade
Universal

0603688000

Detector de humidade para madeira.
Indicação led.
Possibilidade de selecionar entre dois tipos de
madeiras (A o B).



44,00 €

MULTIFERRAMENTA STYLO +

F0132050JA

9W
Velocidade Variável: 5.000-22.000rpm.
Muito leve. Ideal para trabalhos de alta
precisão. c/15 Acessórios.
Bucha aperto rápido



59,00 €

MULTIFERRAMENTA 3000 JC

F0133000JC

130W.
Velocidade Variável: 10.000-33.000rpm.
Bolsa de Neoprene. c/15 Acessórios.



59,00 €

MULTIFERRAMENTA 3000 JS

F0133000JS

130W, Veio Fléxivel. Velocidade Variável:
10.000-33.000rpm. Mala premium e porta
ferramentas. c/25 Acessórios



82,00 €

MULTIFERRAMENTA 4250 JA

F0134250JA

175W
Velocidade Variável. 5.000-35.000rpm.
C/35 Acessórios. (S/Veio Flexível)
Bucha de aperto rápido. Mala de lona.
Ponta EZ TWIST- Troca de acessórios s/chave



107,00 €

MULTIFERRAMENTA 4250 JF

F0134250JF

175W
Velocidade Variável. 5.000-35.000rpm.
Ponta EZ TWIST. Troca de acessórios s/ chave. C/45
Acessórios, 6 multifix. (Veio fléxivel, guia circular e linear
e resguardo de proteção. Escantilhão de modelagem.
Cabeça angular. Set corte multiusos e punho detalhista.
Mala de alumínio

155,00 €

PISTOLA TERMOFUSÍVEL 930

F0130930JA

2 Temperaturas 105°C e 165°C
c/ Oferta 18 barras de cola de 7mm



23,00 €

PISTOLA TERMOFUSÍVEL 940

F0130940JA

Temperatura alta 195°C
Para barras de cola de 11mm



39,00 €

SOLDADOR 2000 JA

F0132000JA

Soldador de gás butano c/6 acessórios
(Solda, faca de corte, bico plano, espalhador de chama,
defletor, cabeça de sopro)
Estanho, esponja, caixa metálica



44,00 €

GRAVADOR 290 JM

F0130290JM

290 JM" c/ ponta. 35W. 6.000gpm Para gravar ou
decorar em metal, plástico, vidro, cerâmica madeira ou
couro. Oferta escantilhão e ponta.



30,00 €



MÁQUINA LAVAR ALTA PRESSÃO GHP 5-65

0600910500

Pressão Máxima: 160bar
Motor: 2,4kw
Caudal: 520lt/h
Mangueira Reforçada: 8m
c/Auto Stop



Equipada c/ lança vá-
rio alta e baixa pressão
e lança rotativa

572,00 €

MÁQUINA LAVAR ALTA PRESSÃO GHP 5-75

0600910700

Pressão Máxima: 185bar
Motor: 2,6kw
Caudal: 570lt/h
Mangueira Reforçada: 8m
Pressão Ajustável
c/Auto Stop



Equipada c/ lança vá-
rio alta e baixa pressão
e lança rotativa

Bomba
latão

~~622 €~~
595,00 €

MÁQUINA LAVAR ALTA PRESSÃO GHP 5-75 X

0600910800

Pressão Máxima: 185bar
Motor: 2,6kw
Caudal: 570lt/h
Mangueira Reforçada: 10m
Pressão Ajustável
C/ Enrolador de Mangueira
c/Auto Stop



Equipada c/ lança vá-
rio alta e baixa pressão
e lança rotativa

Bomba
latão

~~706 €~~
675,00 €

MÁQUINA LAVAR ALTA PRESSÃO AQUATAK 125

06008A7A00

Pressão Máxima: 125bar
Motor: 1,5kw
Caudal: 360lt/h
Mangueira Alta Pressão: 5m
Bico 3 em 1 (Jet, Rotativo e Baixa Pressão).
Bico detergente.



C/OFERTA
KIT LAVA CARROS
(Até Esgotar Stock)

~~160 €~~
153,00 €

MÁQUINA LAVAR ALTA PRESSÃO AQUATAK 130

06008A7B00

Pressão Máxima:
130bar
Motor: 1,7kw
Caudal: 380lt/h
Mangueira Alta Pressão: 6m
Bico 3 em 1 (Jet, Rotativo e Baixa Pressão).
Bico detergente



C/OFERTA
KIT LAVA CARROS
(Até Esgotar Stock)

~~181 €~~
173,00 €

MÁQUINA LAVAR ALTA PRESSÃO AQUATAK 135

06008A7C00

Pressão Máxima: 135bar
Motor: 1,9kw
Caudal: 410lt/h
Mangueira Alta Pressão: 7m
Bico 3 em 1 (Jet, Rotativo e Baixa Pressão).
Bico detergente.



C/OFERTA
KIT LAVA CARROS
(Até Esgotar Stock)

~~204 €~~
195,00 €

Corta Relva + Aparador de relva
ARM 32 + EASYGRASS CUT 23

0600885B03 + 06008C1H00

ARM 32
1.200W
Lâmina: 32cm
Saco: 31 Lt

PVP=125€



EASYGRASS CUT 23
280W
Alimnetação de fio semi-auto
Ø de corte: 23 cm

PVP=48€

Poupança
48 €

125,00 €

Corta Relva
ARM 34

06008A6101

1.300W
Lâmina: 34
Saco: 40 Lt



179,00 €

Corta Relva
ARM 37

06008A6201

1.400W
Lâmina: 40cm
Saco: 40 Lt



214,00 €

Aparador de Relva
EASYGRASS CUT 23

06008C1H01

280W
Alimnetação de fio semi-auto
Ø de corte: 23 cm



48,00 €

Aparador de Relva
ART 24

06008A5800

400W
Alimnetação de fio automática
Ø de corte: 24 cm



75,00 €

Aparador de Relva
ART 30

06008A5400

550W
Alimnetação de fio automática
Ø de corte: 30 cm



94,00 €

Aparador de Relva
ART 35

0600878M00

600W
Alimnetação de fio automática
Ø de corte: 35 cm



130,00 €

Corta Sebes
AHS 45-16

0600847A05

420W
Lâmina: 45 cm



74,00 €

Corta Sebes
AHS 55-16

0600847C02

450W
Lâmina: 55 cm



96,00 €

Corta Sebes
UNIVERSAL EDGE CUT 50

06008C0501

450W. Lâmina de 50 cm.
Diâmetro de corte de 26 mm.

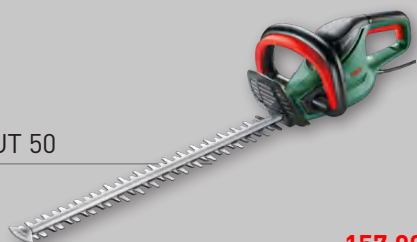

157,00 €

Corta Sebes
UNIVERSAL EDGE CUT 65

06008C0801

450W. Lâmina de 65 cm.
Diâmetro de corte de 34 mm.

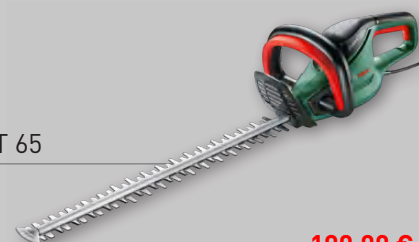

190,00 €

ELETROSERRA
UNIVERSAL CHAIN 35

06008B8300

1.800W
Lâmina: 35cm



124,00 €

SERRA DE JARDIM
KEO 18V

0600861A00

c/ Bateria de Lítio 18V
Lâmina em Aço p/ madeira.
Sistema SDS.
Corta ramos até 80mm.
1,3Kg

VÁRIAS APLICAÇÕES



167,00 €

SOPRADOR ASPIRADOR TRITURADOR
UNIVERSAL GARDEN TIDY 2300

06008B1002

2.300W
290kW/h



128,00 €

TRITURADOR
AXT RAPID 2000

0600853500

2.000W



292,00 €

EXPOSITOR C/47 ACESSÓRIOS LINHA EXPERT

| Referência | Descrição | Quantidade | PVP Uni |
|------------|---|------------|-----------|
| 2608900072 | Broca SDS plus-7x (Betão Armado): 6x100x165mm | 4 | 9,45€ |
| 2608900088 | Broca SDS plus-7x (Betão Armado): 8x100x165mm | 4 | 11,17€ |
| 2608900097 | Broca SDS plus-7x (Betão Armado): 10x100x165mm | 4 | 13,18€ |
| 2608900574 | Broca HEX-9 MultiConstruction: 6 x 60 x 100mm | 4 | 4,73€ |
| 2608900581 | Broca HEX-9 MultiConstruction: 8 x 50 x 100mm | 4 | 5,96€ |
| 2608900595 | Broca HEX-9 HardCeramic: set 3 uds: 5; 6; 8mm | 3 | 43,17€ |
| 2608900561 | Lâminas Serra Tico-Tico p/ INOX - T118AHM: Pack 3uds | 4 | 43,41€ |
| 2608900024 | Lâmina Multiferramenta p/ Multimaterial - AIZ32APIT: 1ud | 4 | 31,17€ |
| 2608900450 | Serra Craneana Multimaterial 68mm c/ adaptador (starter Kit) (p/ Madeira, Aço, Plástico, Cerâmica Macia, Alvenaria) | 2 | 62,44€ |
| 2608900363 | Lâmina Serra de Sabre p/ INOX - S1022EHM: (2~4mm) 1ud | 4 | 32,05€ |
| 2608900368 | Lâmina Serra de Sabre p/ AÇO - S1155CHC (4~12mm) 1ud | 4 | 40,07€ |
| 2608901192 | Disco Abrasivo Multi Wheel Multimaterial: 115x22,2mm (p/ Madeira c/ Pregos + Madeira Dura + Pladur + Plásticos) | 4 | 15,40€ |
| 2608900669 | Disco de Diamante Multimaterial: 115x22,2x2,4(12mm) (p/ Betão + Betão Armado + Pedra + Tijolo) | 2 | 77,60€ |
| Total | | 47 | 1 235,95€ |

- Atraente display
- Produtos Bosch EXPERT: As melhores soluções para cada desafio
- Os mais resistentes, duráveis, mais rápidos: até 100 vezes melhor desempenho
- Tecnologias avançadas para as aplicações mais exigentes

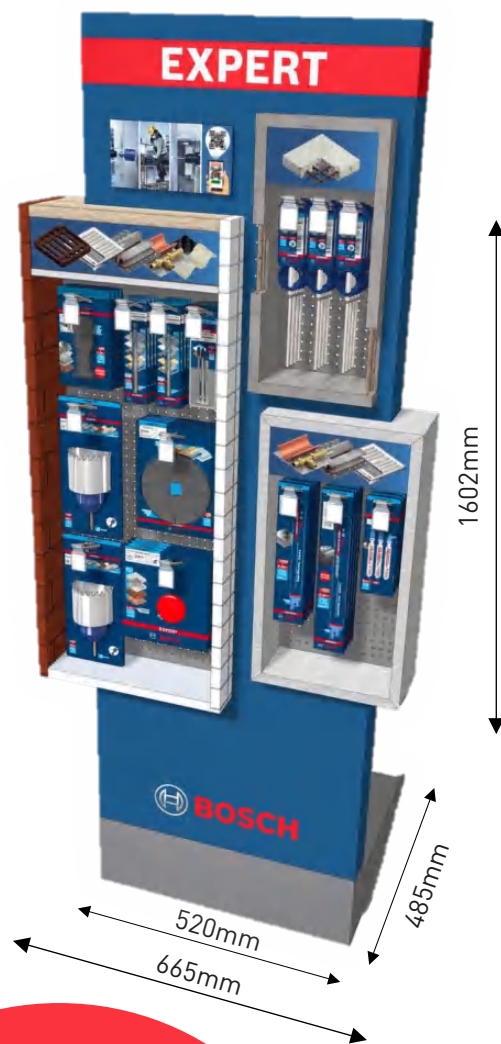

649 €
(Preço líquido)
PVP=1.235,95€

Poupança
+/-48%

OFERTA
1 Cafeteira +
1 Smartwatch





**DISCO PRISMA CERAMIC BEST FOR METAL+INOX
R782 (X-LOCK)**



Ø115mm
(Pack 25)

| Grão | Ref | Preço |
|------|------------|---------------|
| 36 | 2608621820 | 2,65 € |
| 60 | 2608621821 | 1,88 € |
| 80 | 2608621822 | 1,88 € |
| 120 | 2608621823 | 1,88 € |

NOTA: Equivalente ao disco
CUBITRON da 3M



Ø125mm
(Pack 25)

| Grão | Ref | Preço |
|------|------------|---------------|
| 36 | 2608621824 | 3,06 € |
| 60 | 2608621825 | 2,16 € |
| 80 | 2608621826 | 2,16 € |
| 120 | 2608621827 | 2,16 € |

NOTA: Compatível c/rebarbadoras
X-LOCK e Normais

**DISCO PRISMA CERAMIC BEST FOR METAL
R781(X-LOCK)**



Ø115mm
(Pack 25)

| Grão | Ref | Preço |
|------|------------|---------------|
| 36 | 2608621791 | 2,41 € |
| 60 | 2608621792 | 1,72 € |
| 80 | 2608621793 | 1,72 € |

NOTA: Equivalente ao disco
CUBITRON da 3M



Ø125mm
(Pack 25)

| Grão | Ref | Preço |
|------|------------|---------------|
| 36 | 2608621794 | 2,78 € |
| 60 | 2608621795 | 1,96 € |
| 80 | 2608621796 | 1,96 € |

NOTA: Compatível c/rebarbadoras
X-LOCK e Normais

**DISCO PLÁSTICO SUPORTE DISCO FIBRA
(X-LOCK)**



Ø115mm

| Dureza | Ref | Preço |
|-----------|------------|----------------|
| Macio | 2608601711 | 19,56 € |
| Meio Duro | 2608601712 | 18,58 € |
| Duro | 2608601713 | 21,24 € |



Ø125mm

| Dureza | Ref | Preço |
|-----------|------------|----------------|
| Macio | 2608601714 | 19,56 € |
| Meio Duro | 2608601715 | 22,37 € |
| Duro | 2608601716 | 25,17 € |

**DISCO NYLON AUTOVENTILADOS
SUPORTE DISCOS FIBRA**

NOTA: Disco meio duro p/Grão >60

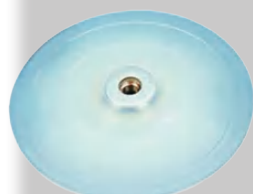

Ø115mm

| Dureza | Ref | Preço |
|-----------|------|---------------|
| Meio Duro | 2825 | 7,15 € |
| Duro | 2828 | 6,84 € |



Ø125mm

| Dureza | Ref | Preço |
|-----------|------|---------------|
| Meio Duro | 2826 | 7,68 € |
| Duro | 2829 | 7,31 € |

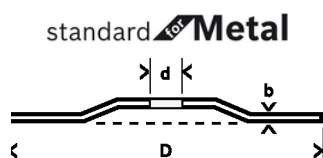
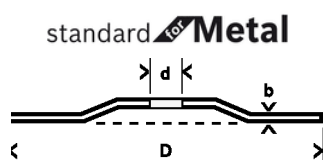
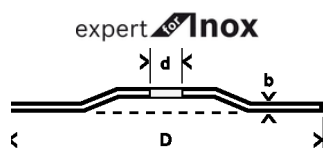
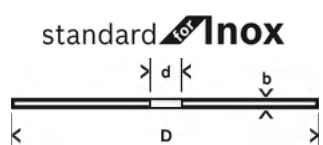

| | Ø Disco | Ref. | Cx | Preço |
|---------------------------|---------------|------------|----|---------------|
| Corte Inox Plano STD | 115x1.0 | 2608603169 | 25 | 0,73 € |
| Corte Inox Concavo STD | 230x1.9 | 2608601514 | 25 | 2,12 € |
| Corte Inox Concavo Expert | 230x1.9 | 2608600711 | 25 | 3,30 € |
| Corte Aço STD | 115x2.5 | 2608603159 | 25 | 1,00 € |
| | 125x2.5 | 2608603160 | 25 | 1,32 € |
| | 180x3.0 | 2608603161 | 20 | 1,68 € |
| | 230x3.0 | 2608603162 | 25 | 1,73 € |
| Corte Aço Expert | 350x2.8(25.4) | 2608600543 | 10 | 7,36 € |
| Rebarbar Aço STD | 115x6 | 2608603181 | 10 | 1,64 € |
| | 125x6 | 2608603182 | 10 | 2,04 € |
| | 180x6 | 2608603183 | 10 | 2,56 € |
| | 230x6 | 2608603184 | 10 | 3,86 € |

DISCOS LAMELADOS P/ INOX

best for Metal



Abrasivo de alumina de **ZIRCÓNIO** e óxido de alumínio

| Ø Disco | Ref. | Cx | Preço |
|---------|------------|----|---------------|
| 115 | 260860545x | 10 | 2,25 € |
| 125 | 260860692x | | 2,58 € |

GRÃO: 40 - 60 - 80

best for Flat+Edge



TACOS ABRASIVOS
97x69x26mm - 2608901169/70/80
(GRÃO: MÉDIO - FINO - SUPER FINO)
Cx50 - **0,69 €**

10CX-DESCONTO EXTRA 10%

best for Wood+Paint



SET TACOS ABRASIVOS
97x69x26mm - 2608901175
(GRÃO: MÉDIO - FINO - SUPER FINO)
Unidade de venda 5 Packs

4,18 €

best for Contour

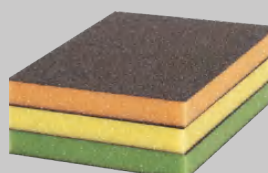

SET ESPONJAS ABRASIVAS
120x98x13mm - 2608901176
(GRÃO: MÉDIO - FINO - SUPER FINO)
Unidade de venda 5 Packs

4,18 €

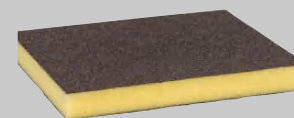

ESPONJAS ABRASIVAS
120x98x13mm - 2608901171/72/73
(GRÃO: MÉDIO - FINO - SUPER FINO)
Cx50 - **0,72 €**



Lata 10
e/ou
cx 25

Corte Inox

| | Expert | STD |
|-------|---------------|---------------|
| 115x1 | 1,54 € | 0,73 € |
| | 2608619263 | 260819266 |
| 125x1 | 1,54 € | 1,10 € |
| | 260819264 | 2608619267 |

Cx 25



CX 10

Rebarbar Aço

| | Expert | STD |
|-------|---------------|---------------|
| 115x6 | 2,32 € | 1,58 € |
| | 2608619258 | 2608619365 |
| 125x6 | 2,76 € | 2,00 € |
| | 2608619259 | 2608619366 |



CERTIFICADO

DISCO ABRASIVO CARBONETO MULTIMATERIAL (MULTI WHEEL) P/Rebarbadora

| Ref. | Ø Disco | Preço |
|------------|---------|----------------|
| 2608901196 | 76 | 13,30 € |
| 2608901192 | 115 | 15,40 € |
| 2608901193 | 125 | 20,50 € |

CORTE DE MADEIRA DURA, MADEIRA c/ PREGOS, PLÁSTICO, PLADUR



CX 25

Corte Aço Expert (Concavo/Reto)

| | | |
|---------|---------------|------------|
| 115x2.5 | 1,58 € | 2608619256 |
| 125x2.5 | 1,58 € | 2608619255 |

Nota: Ref 2608619255 - Disco reto



CX 25

Corte Multi-Construção

| | | |
|-------|---------------|------------|
| 115x1 | 2,00 € | 2608619268 |
| 125x1 | 2,32 € | 2608619269 |

(METAL-INOX-LIGAS NÃO FERROSAS-
PEDRA-LADRILHOS-MARMORE-PLÁSTICO)



CX 10

Disco Lamelado BEST METAL

| | | |
|-----|---------------|------------|
| 115 | 2,35 € | 260861919x |
| 125 | 2,76 € | 260861920x |

(P40-P60-P80-P120)



EXPERT HARD CERÂMIC
Corte cerâmico até 3x mais preciso

| | |
|-----------------------|--------------------------------------|
| 85x1.6x7mm Pastilha | 2608900656 - X-Lock - 20,00 € |
| 115x1.4x10mm Pastilha | 2608900657 - X-Lock - 35,30 € |
| 125x1.4x10mm Pastilha | 2608900658 - X-Lock - 41,90 € |



Corte Cerâmica
Muito Dura e Porcelânico

| | |
|----------------------|---|
| 115x1,4x7mm Pastilha | 2608615131 - X-lock) - 30,80 € (2608602478) |
| 125x1,4x7mm Pastilha | 2608615132 - X-Lock - 32,20 € |

best Ceramic extraclean
Grés fino: Mármore, Pedra,
Granito, Azulejo, Cerâmica



Azulejo, Cerâmica
Corte Cerâmica
ou azulejo

| | |
|----------------------|--------------------------------------|
| 115x1,6x7mm Pastilha | 2608615137 - X-lock - 12,80 € |
| 125x1,6x7mm Pastilha | 2608615138 - X-lock - 14,20 € |

230x1,6x7mm Pastilha
2608602205 - **49,80 €**



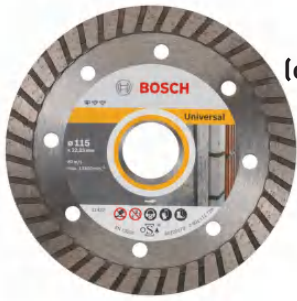

UNIVERSAL STD TURBO
(c/ 10mm de pastilha diamantada)

- Ø115x2,0 - 2608602393 **13,80 €**
- Ø125x2,0 - 2608602394 **16,20 €**
- Ø230x2,0 - 2608602397 **34,90 €**

standard **Universal**



UNIVERSAL STD SEGMENTADO
(c/ 10mm de pastilha diamantada)

- Ø115x2,0 - 2608615165 (x-lock) **8,80 €**
- Ø125x2,0 - 2608615166 (x-lock) **14,20 €**
- Ø230x2,0 - 2608615065 **23,50 €**



EXPERT MULTIMATERIAL
CORTE BETÃO, BETÃO ARMADO,
PEDRA, TIJOLO

Dura até 4X mais que um disco similar
Gume de corte muito duradouro

115x2,4x12 - 2608900669 **77,60 €**



EXPERT MULTIMATERIAL
SEGMENTADO

15mm de pastilha diamantada

Dura até 4X mais que um disco similar
Gume de corte muito duradouro

230x2,4x15 - 2608900663 **117,20 €**

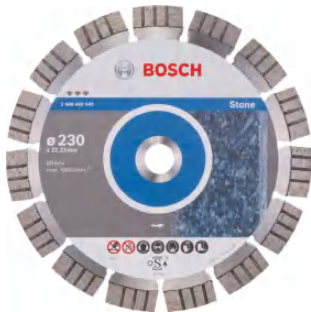

best **Stone**
BEST STONE

15mm de pastilha diamantada

Ótimos resultados em todos os tipos
de pedra natural dura. (Exemplo: granito
ou Betão Armado)

IDEAL PARA CORTE DE GRANITO

230x2,4x15 - 2608602645 **117,20 €**

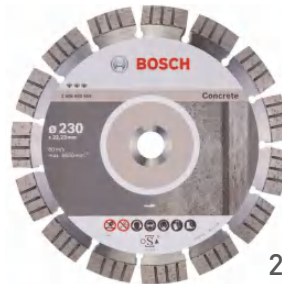

best **Concrete**

BEST CONCRETO

15mm de pastilha diamantada

IDEAL PARA CORTE DE BETÃO

Betão Endurecido e

Betão Armado

230x2,4x15 - 2608602655 **134,20 €**

Mó Tipo Taça Diamantada EXPERT CONCRET



GRINDING HEAD (EXPERT)

D125 (22,23)
2608900651 - **116,80 €**



LONG LIFE - D.115

18 Segmentos de Diamante
2608601761 - **43,00 €**

LONG LIFE - D.125

18 Segmentos de Diamante
2608601762 - **51,60 €**

HIGH SPEED - D.125-9

Segmentada Diamantada
2608601763 - **51,60 €**



| REF. | MEDIDA (mm) | Qty. | Preço Uni. |
|------------|-------------|------|------------|
| 2608577178 | 1.0 | 10 | 0,50 € |
| 2608577183 | 1.5 | 10 | 0,50 € |
| 2608577188 | 2.0 | 20 | 0,50 € |
| 2608577193 | 2.5 | 30 | 0,56 € |
| 2608577198 | 3.0 | 80 | 0,56 € |
| 2608577203 | 3.5 | 30 | 0,56 € |
| 2608577208 | 4.0 | 70 | 0,68 € |
| 2608577213 | 4.5 | 20 | 0,91 € |
| 2608577218 | 5.0 | 50 | 0,91 € |
| 2608577223 | 5.5 | 20 | 1,13 € |
| 2608577228 | 6.0 | 30 | 1,24 € |
| 2608577233 | 6.5 | 10 | 1,36 € |
| 2608577238 | 7.0 | 10 | 1,70 € |
| 2608577243 | 7.5 | 10 | 1,93 € |
| 2608577248 | 8.0 | 20 | 1,93 € |
| 2608577253 | 8.5 | 10 | 2,27 € |
| 2608577258 | 9.0 | 10 | 2,61 € |
| 2608577263 | 9.5 | 10 | 2,61 € |
| 2608577268 | 10.0 | 20 | 2,83 € |
| 2608577273 | 10.5 | 5 | 5,67 € |
| 2608577278 | 11.0 | 5 | 5,67 € |
| 2608577283 | 11.5 | 5 | 6,57 € |
| 2608577288 | 12.0 | 5 | 6,80 € |
| 2608577293 | 12.5 | 5 | 6,80 € |
| 2608577298 | 13.0 | 5 | 6,80 € |

**IF EXPOSITOR DE BALCÃO
C/500 BROCAS**



529 €

EC

2 vezes mais rápida e até 7 vezes mais duradoura que outras brocas HSS-R do Mercado

LOTE BOSCH 4420

**REBARBADORA
GWS 880 - 125**

0601396009
Rebarbadora 880W;
Disco: 115/125mm



OFERTA

PVP **77,00€**

**CONJUNTO DE BROCAS
EM PROBOX**



Conjunto 19 Brocas
(1-10 - 0,5/0,5)

23,40 €

2608577351

HF



Conjunto 25 Brocas
(1-13 - 0,5/0,5)

48,20 €

2608577352

HF

**NA COMPRA 5 DISCOS
DIAMOND METAL 115**

(2608900532)
LOTE BOSCH 6550

C/PVP uni=19,50€ **EC**



**OFERTA
GWS 750
PVP=66€**



122 €
SAI CADA DISCO A 11,20€ **EC**



Corta todo o tipo de metais, aço, ferro fundido
Até 100 vezes mais vida útil que disco abrasivo convencional

VANTAGENS

(ATÉ 100 VEZES MAIS VIDA ÚTIL QUE UM DISCO ABRASIVO CONVENCIONAL) - SEM DATA DE VALIDADE
• CORTA TODO O TIPO DE METAIS
• CORTE MAIS BASTO EM AÇO MAS DE MAIOR QUALIDADE EM FERRO FUNDIDO

Discos Diamond METAL WHEEL **HF**

| | | |
|-----|----------------|------------|
| 115 | 24,00 € | 2608900532 |
| 125 | 31,20 € | 2608900533 |
| 230 | 75,70 € | 2608900536 |

SERRAS CRANEANAS FRESAS P/TUPIAS

BROCA CENTRADORA P/SERRA CRANEANA



Broca centar HSS-G 8.5x105
2608900529 - **16,56 €**

Broca centar TCT 8.5x105
2608900526 - **15,49 €** IF

ADAPTADOR (ARVORE) P/SERRA CRANEANA C/BROCA



C/Broca 8,5x105
2608900526 - **34,61 €**

C/Broca 7,5x105
2608900527 - **30,73 €** IF

SERRAS CRANEANAS EXPERT MULTIMATERIAL

P/Orifícios até 60mm profundidade



| Ø | Ref | Preço | Ø | Ref | Preço |
|----|------------|----------------|-----|------------|-----------------|
| 20 | 2608900419 | 26,23 € | 67 | 2608900432 | 47,93 € |
| 22 | 2608900420 | 27,45 € | 68 | 2608900433 | 48,88 € |
| 25 | 2608900421 | 27,45 € | 70 | 2608900434 | 48,88 € |
| 32 | 2608900422 | 29,92 € | 73 | 2608900435 | 50,20 € |
| 35 | 2608900423 | 29,92 € | 76 | 2608900436 | 50,20 € |
| 38 | 2608900424 | 31,80 € | 80 | 2608900437 | 52,07 € |
| 40 | 2608900425 | 31,80 € | 83 | 2608900438 | 52,07 € |
| 44 | 2608900426 | 33,68 € | 102 | 2608900439 | 72,44 € |
| 51 | 2608900427 | 35,95 € | 105 | 2608900440 | 74,51 € |
| 54 | 2608900428 | 42,73 € | 111 | 2608900441 | 78,83 € |
| 60 | 2608900429 | 46,44 € | 114 | 2608900442 | 81,12 € |
| 64 | 2608900430 | 46,44 € | 127 | 2608900443 | 90,42 € |
| 65 | 2608900431 | 47,93 € | 152 | 2608900444 | 108,14 € |

SERRAS CRANEANAS EXPERT MULTIMATERIAL Ø51mm ou Ø68mm C/ADAPTADOR

P/Madeira, Aço, Plástico, cerâmica macia, alvenaria,pladur

Conjunto de iniciação composto por:

1 Serra craneana (Ø51 ou Ø68),

1 Adaptador Hex 11, 1 Broca centar

2 Porcas adaptadoras (para serras Ø14- Ø30 e Ø32-Ø210)

Longa durabilidade

Troca rápida



2608900449 - Ø51mm - **57,91 €**

IF

2608900450 - Ø68mm - **62,44 €**

IF

FRESAS DIREITAS 2 CANAIS, CARBONETO ENCABADOURO 8mm



FD

| Medida Ø | Comprimento corte | Comprimento total | Ref | Preço |
|----------|-------------------|-------------------|------------|----------------|
| 6 | 16 | 48 | 2608628379 | 12,61 € |
| 8 | 20 | 51 | 2608628381 | 13,19 € |
| 10 | 20 | 51 | 2608628383 | 13,19 € |
| 12 | 20 | 51 | 2608628385 | 14,91 € |
| 14 | 20 | 51 | 2608628375 | 17,77 € |
| 15 | 20 | 51 | 2608628387 | 15,48 € |
| 16 | 20 | 51 | 2608628388 | 15,48 € |
| 18 | 25 | 56 | 2608628389 | 16,63 € |
| 20 | 25 | 56 | 2608628390 | 19,49 € |
| 22 | 25 | 56 | 2608628391 | 19,49 € |
| 25 | 20 | 51 | 2608628392 | 19,49 € |

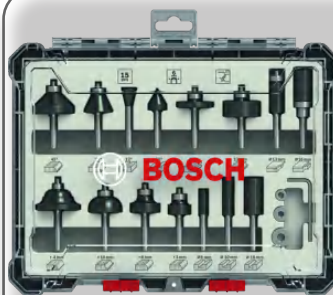

FD

CONJUNTO 15 FRESAS MISTAS

Alinhar - Nivelar - Malhetar - Chanfrar -
Ranhar em V - Entalhe - Talão - Sulcos
- Arredondar - Direita 2 canais -
Direita 3 canais - Serra de ranhar

Conjunto c/encabadoiro 6 - 2607017471 - **113,51 €**

Conjunto c/encabadoiro 8 - 2607017472 - **113,51 €**

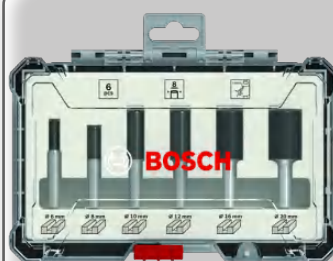

FD

CONJUNTO 6 FRESAS MISTAS

3 Fresas direitas 2 canais
(Ø6-Ø8-Ø10)
3 Fresas direitas 3 canais

Conjunto c/encabadoiro 6 - 2607017465 - **51,60 €**

Conjunto c/encabadoiro 8 - 2607017466 - **51,60 €**



OPTILINE WOOD P/MADEIRA



| Referência | Medida (mm) | Dentes | Preço |
|------------|-------------|--------|----------------|
| 2608640597 | 160x2.6/1.6 | Z=36 | 32,93 € |
| 2608640610 | 184x2.6/1.6 | Z=24 | 28,39 € |
| 2608640611 | 184x2.6/1.6 | Z=36 | 36,34 € |
| 2608640615 | 190x2.6/1.6 | Z=24 | 24,98 € |
| 2608640621 | 210x2.8/1.8 | Z=24 | 31,80 € |
| 2608640622 | 210x2.8/1.8 | Z=36 | 45,42 € |
| 2608640623 | 210x2.8/1.8 | Z=48 | 45,42 € |
| 2608640627 | 230x2.8/1.8 | Z=24 | 36,34 € |
| 2608640725 | 235x2.8/1.8 | Z=24 | 38,61 € |
| 2608640727 | 235x2.8/1.8 | Z=48 | 49,97 € |
| 2608640435 | 254x2.0/1.4 | Z=40 | 56,78 € |
| 2608640440 | 305x2.5/1.8 | Z=40 | 62,46 € |
| 2608640682 | 315x3.2/2,2 | Z=28 | 52,24 € |

MADEIRA



(Furo Interior 20/16mm)

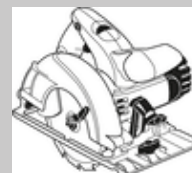

CONSTRUCT WOOD P/MAD. C/PREGOS E/OU BETÃO SERRAS MANUAIS E SERRAS DE MESA DE OBRA



| P/Serras Manuais | Medida (mm) | Dentes | Preço |
|------------------|-------------|--------|----------------|
| 2608640633 | 190x2.6/1.6 | Z=12 | 26,69 € |
| 2608640636 | 235x2.8/1.8 | Z=16 | 34,01 € |
| 2608640691 | 315x3.2/2.2 | Z=20 | 73,76 € |

MADEIRA c/ PREGOS

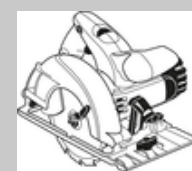

MULTIMATERIAL P/METAIS FERROSOS E ALUMÍNIO SERRAS MANUAIS E MEIA ESQUADRIA



| Referência | Medida (mm) | Dentes | Preço |
|------------|-------------|--------|----------------|
| 2608640503 | 160x2.3/1.8 | Z=42 | 54,51 € |
| 2608640509 | 190x2.4/1.8 | Z=54 | 64,73 € |
| 2608640447 | 216x2.5/1.8 | Z=80 | 78,58 € |
| 2608640514 | 235x2.4/1.8 | Z=64 | 78,01 € |
| 2608640516 | 250x3.2/2.5 | Z=80 | 79,49 € |
| 2608640453 | 305x3.2/2.5 | Z=90 | 97,89 € |

ALUMÍNIO

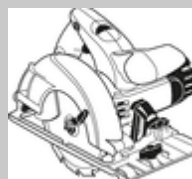

DISCOS PARA CORTE DE PAINEL SANDWICH



| Referência | Medida (mm) | Dentes | Preço |
|------------|-------------|--------|-----------------|
| 2608644367 | 190x2.0/1.6 | Z=36 | 78,35 € |
| 2608644142 | 210x2.4/2.0 | Z=36 | 81,76 € |
| 2608644143 | 235x2.2/1.8 | Z=50 | 113,56 € |
| 2608644145 | 270x2.4/2.0 | Z=60 | 136,27 € |
| 2608644147 | 355x2.6/2.2 | Z=80 | 170,34 € |

SANDWICH

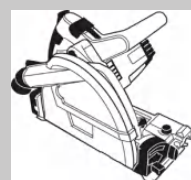

(TODOS OS DISCOS DE SERRA C/FURO INTERIOR DE 30mm)

Nota: Desconto adicional de +10% na compra de 4 discos de serra pastilhados (Iguais ou Sortidos).

LÂMINAS DE SERRA DE SABRE (RABO DE RAPOSA)

for Wood



S 2345 X

2608654403 (2uni) **16,03 €**
2608654404 (5uni) **33,39 €**
Madeira, MDF, Plástico
Espessura: 6-60mm (<150mm)
Dentado HCS cruzado, afiado
200x19x1,25mm



S 644 D

2608650673 (5uni) **26,71 €**
Madeira, MDF, Plástico
Espessura: 6-60mm (<100mm)
Dentado HCS cruzado, Afiado
150x19x1,25mm



S 1531 L

2608650613 (2uni) **18,03 €**
2608650676 (5uni) **37,40 €**
Madeira Bruta s/pregos, Lenha
Espessura: <190mm
Dentado HCS cruzado, Afiado
240x19x1,5mm

for WoodMetal



S 922 HF

2608656016 (5uni) **31,39 €**
Reparação paletes, Madeira c/pregos, Tubos, Chapas
Espessura: 3-12mm (<100mm)
Dentado BIM, cruzado, fresado
150x19x0,9mm



S 1122 HF (Fléxivel WOOD & Metal)

2608656021 (5uni) **40,07 €**
Reparação de paletes, madeira c/pregos (<175mm), chapas de metal, tubos, perfis de alumínio. (3-12mm)
Dentado BIM, Cruzado, fresado
225x19x0,9mm



S 1411 DF

2608654834 (2uni) **25,38 €**
2608654763 (5uni) **50,22 €**
Madeira c/pregos, chapas metal, perfis alumínio e plástico
Espessura: 3-10mm (<175mm)
Dentado BIM, Cruzado, Fresado
225x19x0,9mm



S 3456 XF

2608654406 (5uni) **41,40 €**
Madeira c/pregos, aglomerado, chapas metal, perfis alumínio e plástico.
Espessura: (3-18mm) (<150mm)
Dentado BIM, Cruzado, fresado
250x19x1,25mm

for Metal



S 1122 AF

2608656018 (5uni) **38,06 €**
Chapas, tubos/perfis finos
Espessura: (0-7-3mm) (<175mm)
Dentado BIM, Ondulado, fresado
225x19x0,9mm



S 1122 EF - Fléxivel Metal

2608656042 (2uni) **18,03 €**
Chapas finas (1.5 - 4m)
Tubos/Perfis (Ø<175mm)
Dentado BIM, Cruzado, Fresado
225x19x0,9mm

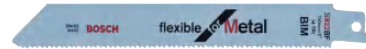

S 922 BF

2608656014 (5uni) **30,72 €**
Chapas, tubos/perfis maciços
Espessura: (3-8mm) (<100mm)
Dentado BIM, cruzado, fresado
150x19x0,9mm



S 1122 BF

2608656041 (2uni) **18,30 €**
2608656019 (5uni) **38,06 €**
Chapas, tubos/perfis maciços
Espessura: (3-8mm) (<175mm)
Dentado BIM, cruzado, Fresado
225x19x0,9mm



S 926 CHF

2608657397 (5uni) **41,70 €**
Aço - Cortes precisos
Chapas, perfis, tubos
Espessura: (4-12mm) (<100mm)
Dentado BIM 2x2 Patent
150x25x1,1mm



S 522 EF

2608657721 (2uni) **16,03 €**
Chapas finas
Espessura: (1.5 - 4mm)
Dentado BIM, Cruzado, fresado
100x19x0,9mm



S 1211 K

2608652900 (5uni) **66,78 €**
Materiais congelados
Espessura: <250mm
Dentado inox, travado, fresado
300x19x1,25mm



S 1122 VFR

2608658030 (5uni) **26,75 €**
Paletes, madeira c/pregos, profundidades de corte até 165mm máxima flexibilidade.
225x19x0,9mm
2608658031(100uni) **285,90 €**
2608658032(200uni) **370,60 €**

Especial
Corte de Paletes

special PalletRepair

EXPERT



S 1022EHM

2608900363 (1uni) **32,05 €**
Chapas Inox (2-4mm)
Perfis Inox <150mm
Plásticos reforçados, fibra de vidro/Epoxy (<150mm)



S 2041 HM

2608900413 (1uni) **53,42 €**
P/Corte betão celular. Os grandes dentes mastigam rapidamente o material. Lâmina robusta e larga p/cortes direitos e precisos. 400x22x1.50mm



S 1155 CHC

2608900368 (1uni) **40,07 €**
P/Corte de aço duro c/espessura 4-12mm.
Capacidade máx corte: 175mm
225x25x1.25mm



S 1157 CHM / S 957 CHM

P/Resgate e desmontagem de veículos.
Espessura de corte: 4 - 12mm
2608900380 (1uni) **39,27 €**
Capacidade máx. corte:175mm.
225x20x1.35mm
S 957 CHM
2608900378 (1uni) **29,45 €**
Capacidade máx. corte:100mm.
150x20x1.35mm

LÂMINAS DE SERRA DE SABRE (RABO DE RAPOSA)



BOSCH

for Wood



T 111 C

2608630033 (5uni) 8,68 €
Madeira macia/aglomerado
Espessura 4-50mm
Dentado HCS cruzado, Fresado
L=100



T 144 D

2608630040 (5uni) 11,14 €
Madeira macia/aglomerado
Espessura 5-50mm
Dentado HCS cruzado, Afiado
L=100



T 344 D

2608633A34 (5uni) 18,59 €
Madeira const grossa
Espessura 5-100mm
Dentado HCS cruzado, Afiado
L=152



T 244 D

2608630058 (5uni) 13,60 €
Madeira macia/aglomerado
Espessura 5-50mm (Curvo)
Dentado HCS cruzado, Afiado
L=100

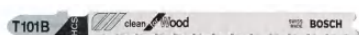

T 101 B

2608630030 (5uni) 12,30 €
Madeira macia/aglomerado
Espessura 3-30mm (Curvo)
Dentado HCS angulo livre, afiado
L=100



T 101 A0

2608630031 (5uni) 12,30 €
Madeira macia/contraplacado
Espessura 1,5-15mm (Curvo)
Dentado HCS Pontiagudo, Afiado
L=83



T 101 D

2608630032 (5uni) 12,30 €
Madeira macia/aglomerado
Espessura 10-45mm
Dentado HCS Angulo livre, afiado
L=100



T 119 B

2608630037 (5uni) 6,00 €
Madeira macia/contraplacado
Espessura 2-15mm
Dentado HCS Ondulado, frisado
L=92



T 234 X

2608633528 (5uni) 22,43 €
Madeira macia/aglomerado
Espessura 3-65mm
Dentado HCS Angulo livre, afiado
L=117



T 308 BP

2608667399 (3uni) (T308BP) 14,47 €
Madeira macia/aglomerado
Espessura 3-65mm
Dentado HCS Angulo livre, afiado
L=117

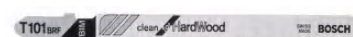

T 101 BRF

2608636227 (5uni) 14,83 €
Madeira dura/laminados
Espessura 3-30mm
Dentado BIM, angulo livre,afiado
L=100



T 718 BF

2608636335 (5uni) 28,94 €
Painel Sandwich
Espessura <120mm
Dentado BIM ondulado, fresado
L=180

T101BK (2608630014) (5uni) -

for Metal



T 118 A

2608631013 (5uni) 12,15 €
Aço
Espessura 1-3mm
Dentado HSS, ondulado, fresado
L=92



T 118 B

2608631014 (5uni) 12,15 €
Aço
Espessura 2,5-6mm
Dentado HSS ondulado, fresado
L=92



T 218 A

2608631032 (5uni) 14,76 €
Aço
Espessura 1-3mm (Curvo)
Dentado HSS, ondulado, fresado
L=92



T 318 A

2608631319 (5uni) 15,92 €
Aço (Chapa + tubos)
Espessura 1-3mm /Tubo <65mm
Dentado HSS ondulado, fresado
L=132

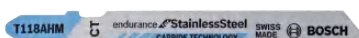

T 118 AHM

2608900561 (3uni) 43,41 €
INOX
Espessura 1,5-3mm
Dentado metal duro, afiado
L=83



T 127 D

2608631017 (5uni) 15,84 €
Alumínio
Espessura 3-15mm tubo <30mm
Dentado HSS, cruzado, fresado
L=100



T 318 BF

2608634242 (5uni) 17,50 €
Chapa perf + Sandwich + Fibra vidro
Espessura 2,5-6mm/ Tubo <65mm
Dentado BIM, fresado, cruzado
L=132



T 121 AF

2608636699 (5uni) 18,09 €
Chapa perfurada
Espessura 1-3mm
Dentado BIM, ondulado, fresado
L=92

ACESSÓRIOS "STARLOCK" P/MULTIFERRAMENTA "GOP"



AII 65 APB **PACK 4**

MADEIRA E METAL
Lâmina 65x40
Madeira c/pregos/metal

2608661781 (1uni) - **20,89 €**



AIZ 32 BSPB **PACK 4**

MADEIRA DURA
Lâmina curva 32x50
Madeira dura

2608661645 (1uni) - **16,53 €**
2608661630 (5uni) - **66,06 €**



AIZ 32 EPC **PACK 4**

MADEIRA
Lâmina curva 32x50
Madeira macia

2608661637 (1uni) - **12,76 €**
2608661626 (5uni) - **51,02 €**



AIZ 32 APB **PACK 4**

MADEIRA E METAL
Lâmina curva 32x50
Madeira, plástico, perfis e tubos não ferrosos.

2608661644 (1uni) - **16,53 €**
2608661629 (5uni) - **66,06 €**



AIZ 32 AB **PACK 4**

METAL
Lâmina 32x50
Corte rente pregos, tubos de cobre, placas de gesso

2608661688 (1uni) - **14,69 €**



ACZ 85 EIB

MULTIMATERIAL
Disco semi-circular Ø85
Corte placas gesso/fibrocimento ao comprido

2608661758 (1uni) - **28,40 €**



ACZ 85 EB **PACK 4**

MADEIRA E METAL
Disco semi-circular Ø85
Corte madeira/laminado/parquet ao comprido

2608661636 (1uni) - **22,20 €**



ATZ 52 SC

MULTIMATERIAL
Espatula 52x26
Remover agrumassas ou colas

2608661646 (1uni) - **9,79 €**



AIZ 32 AT

METAL DURO
Lâmina 32x50
Corte metais duros (Pregos, Tubos)

2609256C65 (1uni) - **28,99 €**



PAIZ 32 APB

MADEIRA E METAL
Lâmina 32x60
Cortes derivados, madeira, plásticos, tubos, perfis não ferrosos, perfis aço pequenos

2608662558 (1uni) - **18,17 €**



AIZ 32 RT5

AGRAMASSA E ABRASIVOS
Lâmina 32x30
Corte fibra de vidro, agrumassa e materiais abrasivos.

2608661868 (1uni) - **28,66 €**



AIZ 32 APIT

EXPERT MULTIMATERIAL
Lâmina curva 32x30
Corte chapa metal, materiais compostos, placas de fibrocimento e tijolos.

2608900024 (1uni) - **31,17 €**



JOGO 6uni STARLOCK

"Eletricidade e Pladur"

- 1 Lâmina AYZ 53 BPB - Pladur
- 2 Lâminas AIZ 32 APB - Madeira e metal
- 1 Lâmina AII 65 APB - Madeira, pregos
- 1 Lâmina AIZ 32 AB - Metal
- 1 Lâmina AIZ 20 AB - Madeira e metal

2608664622 - **56,60 €**



JOGO 5uni STARLOCK

"Melhor para cortar"

- 1 Lâmina AIZ 32 BSPB - Madeira dura
- 1 Lâmina AIZ 32 APB - Madeira e metal
- 1 Semi disco ACZ 85 EB - Madeira e metal
- 1 Lâmina AIZ 32 AT - Metal duro
- 1 Lâmina AII 65 APB - Madeira, Pregos

2608664131 - **47,30 €**



ENCABADOURO SDS-PLUS

| MEDIDA (mm) | Plus 5X | Plus 7X |
|-------------|---------|---------|
| 4x50x110 | 5,50 € | 9,40 € |
| 5x50x110 | 4,24 € | 8,59 € |
| 5x100x160 | 5,04 € | 9,97 € |
| 5x150x210 | 8,48 € | 16,85 € |
| 5.5x50x110 | 4,87 € | 9,40 € |
| 5.5x100x160 | 5,39 € | 10,60 € |
| 5.5x150x210 | 8,59 € | 17,19 € |
| 6x50x110 | 4,30 € | 8,59 € |
| 6x100x160 | 4,76 € | 9,45 € |
| 6x150x210 | 7,91 € | 15,59 € |
| 6x200x260 | 8,88 € | 17,30 € |
| 6x250x310 | 13,75 € | 18,34 € |
| 7x50x110 | 5,73 € | 11,46 € |
| 7x100x160 | 6,42 € | 12,49 € |
| 8x50x110 | 5,50 € | 10,89 € |
| 8x100x160 | 5,62 € | 11,17 € |
| 8x150x210 | 6,70 € | 13,18 € |
| 8x200x260 | 8,37 € | 17,76 € |
| 8x250x310 | 12,38 € | 19,48 € |
| 8x400x460 | 16,04 € | 32,66 € |
| 9x100x160 | 7,33 € | 11,46 € |
| 9x150x210 | 9,05 € | 13,18 € |
| 10x50x110 | 6,59 € | 12,72 € |
| 10x100x160 | 6,59 € | 13,18 € |
| 10x150x210 | 7,79 € | 15,47 € |
| 10x200x260 | 9,74 € | 19,42 € |
| 10x250x310 | 11,23 € | 22,52 € |
| 10x300x360 | 14,90 € | 29,22 € |
| 10x400x460 | 16,04 € | 32,77 € |
| 11x100x160 | 9,17 € | 14,04 € |
| 12x100x160 | 7,56 € | 15,64 € |
| 12x150x210 | 8,82 € | 18,34 € |
| 12x200x260 | 11,23 € | 23,26 € |
| 12x250x310 | 13,64 € | 24,07 € |
| 12x300x365 | 16,50 € | 34,38 € |

| MEDIDA (mm) | Plus 5X | Plus 7X |
|-------------|---------|----------|
| 12x400x460 | 16,62 € | 41,03 € |
| 12x550x610 | 33,81 € | 74,49 € |
| 12x950x1000 | - | 183,36 € |
| 13x100x160 | 11,12 € | 18,34 € |
| 14x100x160 | 11,12 € | 22,92 € |
| 14x150x210 | 12,49 € | 25,96 € |
| 14x200x260 | 13,98 € | 28,94 € |
| 14x250x310 | 15,01 € | 30,08 € |
| 14x300x365 | 18,51 € | 41,39 € |
| 14x400x460 | 20,63 € | 48,70 € |
| 14x950x1000 | - | 200,54 € |
| 15x100x160 | 13,64 € | 27,96 € |
| 15x200x260 | 18,22 € | 37,53 € |
| 16x150x210 | 16,04 € | 33,35 € |
| 16x200x260 | 18,11 € | 37,07 € |
| 16x250x310 | 18,68 € | 41,47 € |
| 16x300x360 | 24,50 € | - |
| 16x400x460 | 27,50 € | 66,35 € |
| 16x550x600 | 35,53 € | 0,00 € |
| 16x950x1000 | - | 0,00 € |
| 18x150x200 | 27,27 € | - |
| 18x250x300 | 33,81 € | - |
| 18x400x450 | 29,80 € | 74,49 € |
| 18x550x600 | 52,71 € | 97,41 € |
| 20x150x200 | 32,77 € | - |
| 20x250x310 | 37,82 € | - |
| 20x400x450 | 34,38 € | 80,22 € |
| 20x950x1000 | - | 229,19 € |
| 22x200x250 | 47,90 € | 85,95 € |
| 22x400x450 | 45,84 € | 103,14 € |
| 22x550x600 | 85,95 € | 154,71 € |
| 24x20x250 | 53,98 € | - |
| 24x400x450 | 59,59 € | 108,87 € |
| 25x400x450 | 64,17 € | 131,79 € |
| 26x200x250 | 60,39 € | - |
| 26x400x450 | 66,47 € | - |

● Unidade de venda: Blister c/10 uni
Desconto EXTRA = 10%
NAS BROCAS PLUS 5X

COROA C/DIAMANTE EXPERT FOR CERAMIC IF

| Ø | Ref | Preço |
|----|------------|---------|
| 6 | 2608599049 | 23,95 € |
| 8 | 2608599050 | 25,95 € |
| 10 | 2608599051 | 26,95 € |
| 12 | 2608599052 | 27,95 € |



SDS-PLUS 5X - 4 ARESTAS DE CORTE

| REFERÊNCIA | MEDIDA (mm) | UNI |
|------------|-------------|-----|
| 2608836604 | 4x50x115 | 5 |
| 2608833771 | 5x50x110 | 10 |
| 2608833772 | 5x100x160 | 10 |
| 2608833777 | 6x50x110 | 10 |
| 2608833778 | 6x100x160 | 10 |
| 2608833779 | 6x150x210 | 10 |
| 2608833788 | 8x50x110 | 10 |
| 2608833789 | 8x100x160 | 10 |
| 2608833790 | 8x150x210 | 10 |
| 2608833798 | 10x100x160 | 10 |
| 2608833799 | 10x150x210 | 10 |
| 2608833800 | 10x200x260 | 10 |
| 2608833807 | 12x100x160 | 10 |
| 2608833808 | 12x150x210 | 10 |

Display c/ 135 brocas Plus 5x
PVP = 873,20€



499 € EC



0601396009

Rebarbadora 880W;
Disco: 115/125mm

PVP 77,00€

LOTE BOSCH 4565

PLUS 5 - PLUS 5X



Não fica presa no betão armado
4 arestas ao preço de 2

SDS-PLUS 7X - P/BETÃO ARMADO

| REFERÊNCIA | MEDIDA (mm) | UNI |
|------------|-------------|-----|
| 2608576102 | 4x50 x 115 | 5 |
| 2608576104 | 5x50x115 | 10 |
| 2608576105 | 5x100x165 | 10 |
| 2608576116 | 6x50x115 | 10 |
| 2608576117 | 6x100x165 | 10 |
| 2608576118 | 6x150x215 | 5 |
| 2608576130 | 8x50x115 | 10 |
| 2608576131 | 8x100x165 | 10 |
| 2608576132 | 8x150x215 | 5 |
| 2608576140 | 10x100x165 | 10 |
| 2608576141 | 10x150x215 | 5 |
| 2608576142 | 10x200x265 | 5 |
| 2608576149 | 12x100x165 | 5 |
| 2608576150 | 12x150x215 | 5 |

Display c/ 105 brocas Plus 7x
PVP = 1.253,60€



689 € EC



0601396009

Rebarbadora 880W;
Disco: 115/125mm

PVP 77,00€

LOTE BOSCH 4590

PLUS 7 - PLUS 7X

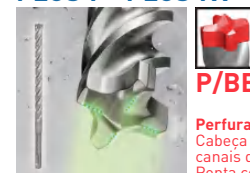

P/BETÃO ARMADO

Perfura s/ dificuldade no betão armado
Cabeça maciça de 4 arestas. Longos canais de evacuação.
Ponta centradora.

BROCAS PARA FURAR PEDRA/BETÃO E BROCAS ENCABADOURO CILÍNDRICO

MAX M4 KH4

| MEDIDA | PREÇO |
|--------|----------|
| 16x340 | 45,78 € |
| 16x540 | 57,24 € |
| 18x340 | 45,78 € |
| 18x540 | 57,24 € |
| 20x320 | 49,22 € |
| 20x520 | 56,10 € |
| 22x320 | 51,51 € |
| 22x520 | 59,53 € |
| 24x320 | 62,97 € |
| 24x520 | 80,16 € |
| 25x320 | 62,97 € |
| 25x520 | 80,16 € |
| 28x320 | 66,41 € |
| 28x520 | 80,16 € |
| 30x320 | 68,70 € |
| 30x520 | 80,16 € |
| 32x320 | 74,43 € |
| 32x520 | 88,18 € |
| 35x520 | 98,50 € |
| 40x520 | 142,10 € |



NA COMPRA DE 3 BROCAS MAX-M4 SORTIDAS DESCONTO EXTRA 10%

MAX 8X (MAX 7) KH4

| MEDIDA | PREÇO | MEDIDA | PREÇO |
|--------|----------|--------|----------|
| 16x340 | 96,83 € | 25x320 | 123,76 € |
| 16x540 | 113,45 € | 25x520 | 143,25 € |
| 18x340 | 102,28 € | 25x720 | 186,79 € |
| 18x540 | 120,33 € | 25x920 | 231,49 € |
| 18x740 | 152,99 € | 28x520 | 162,73 € |
| 18x940 | 186,79 € | 28x720 | 209,71 € |
| 20x320 | 108,29 € | 28x920 | 257,84 € |
| 20x520 | 121,47 € | 30x520 | 175,33 € |
| 20x720 | 156,42 € | 32x520 | 192,52 € |
| 20x920 | 198,54 € | 35x520 | 221,75 € |
| 22x320 | 114,60 € | 35x920 | 427,45 € |
| 22x520 | 131,21 € | 40x520 | 319,73 € |
| 22x920 | 193,67 € | 40x720 | 391,92 € |
| 24x320 | 125,20 € | 40x920 | 439,48 € |
| 24x520 | 143,25 € | 45x520 | 403,38 € |
| | | 52x520 | 511,68 € |



4 GUMES DE CORTE EM "S" DE METAL DURO C/DESIGN DE 2+2 ESPIRAIS

- PERFURAÇÃO MAIS RÁPIDA
- REDUÇÃO DA VIBRAÇÃO
- EXCELENTE TRANSMISSÃO DE FORÇA E VELOCIDADE
- CABEÇA COMPOSTA DE CARBONETO ATÉ 16MM, DURA MAIS EM BETÃO ARMADO

● Unidade de venda: Blister c/5 uni
Desconto EXTRA = 25%



CONJ. BROCAS CILÍNDRICAS E HEX-9 IF

SET CYL-3 EXPERT

2608597709
5-6-8mm
7,59 €

SET EXP HEX-9 HARD CERAMIC

2608900595
5-6-8mm
43,17 €

SET CYL-9 ROBUSTLINE MULTI CONSTRUCTION

2608900645
4-5-6-8mm
20,16 €

SET CYL-9 EXPERT MULTI CONSTRUCTION

2608900649
4-5-6-8mm
19,81 €

BROCA EXPERT HEX-9 IF

HARD CERAMIC PONTA DA BROCA EXTREMAMENTE DURA
(26089005xx)

| DIÂMETRO | PREÇO |
|----------|---------|
| 4 | 13,44 € |
| 5 | 13,96 € |
| 6 | 14,61 € |
| 7 | 15,13 € |
| 8 | 19,81 € |
| 10 | 23,31 € |
| 12 | 24,48 € |

BROCA EXPERT HEX-9 MULTICONSTRUCTION
(26089005xx)

| DIÂMETRO | PREÇO |
|----------|---------|
| 4 | 4,24 € |
| 5 | 4,50 € |
| 6 | 4,73 € |
| 8 | 5,96 € |
| 10 | 8,18 € |
| 12 | 10,69 € |

BROCAS CILÍNDRICAS IF

CYL-9 CERAMIC AZULEJO E VIDRO
(26085871xx)

| DIÂMETRO | PREÇO |
|----------|---------|
| 4 | 5,43 € |
| 5 | 6,19 € |
| 6 | 6,19 € |
| 8 | 8,12 € |
| 10 | 9,46 € |
| 12 | 10,28 € |



CYL-9 MULTICONSTRUCTION MULTIUSO
(26089006xx)

| DIÂMETRO | PREÇO |
|----------|---------|
| 4 | 4,23 € |
| 5 | 4,50 € |
| 6 | 4,73 € |
| 7 | 5,43 € |
| 8 | 5,96 € |
| 10 | 8,18 € |
| 11 | 10,52 € |
| 12 | 10,69 € |



CYL-5 PEDRA/GRANITO
(26085881xx)

| DIÂMETRO | PREÇO |
|----------|--------|
| 4 | 3,62 € |
| 5 | 3,62 € |
| 6 | 3,86 € |
| 7 | 4,67 € |
| 8 | 4,91 € |
| 10 | 6,72 € |
| 12 | 8,88 € |



CYL-3 PEDRA/BETÃO
(26085976xx)

| DIÂMETRO | PREÇO |
|----------|---------|
| 3 | 2,39 € |
| 4 | 2,39 € |
| 5 | 2,22 € |
| 6 | 2,51 € |
| 7 | 3,15 € |
| 8 | 3,27 € |
| 9 | 3,59 € |
| 10 | 4,15 € |
| 11 | 5,26 € |
| 12 | 5,78 € |
| 13 | 7,18 € |
| 14 | 8,18 € |
| 16 | 11,98 € |





PONTEIROS SDS-PLUS

| TIPO | MEDIDA (mm) | REF. | PREÇO | |
|--------------------------------------|-------------|------------|----------------|--|
| PONTEIRO BICO LONG LIFE (STD) | 250 | 2608690132 | 11,50 € | |
| PONTEIRO BICO Auto Afiável | 250 | 2607019051 | 15,94 € | |
| PONTEIRO CHATO (Cinzel) (STD) | 250x20 | 2608690131 | 11,50 € | |
| PONTEIRO CHATO (Cinzel) Auto Afiável | 250x20 | 2607019052 | 15,94 € | |
| PÁ (STD) | 250x40 | 2608690133 | 20,61 € | |
| CINZEL P/ AZULEJO | 250x40 | 2608690091 | 38,07 € | |

PONTEIROS SDS-MAX

| TIPO | MEDIDA (mm) | REF. | PREÇO | |
|--|-------------|------------|-----------------|--|
| PONTEIRO BICO (ECO) | 400 | 2608690235 | 9,30 € | |
| PONTEIRO BICO (STD) | 400 | 2608690128 | 12,90 € | |
| PONTEIRO BICO R-TEC Auto Afiável (Retorcido) | 400 | 2608690168 | 16,80 € | |
| PONTEIRO BICO (STD) | 600 | 2608690129 | 25,72 € | |
| PONTEIRO CHATO (Cinzel) (ECO) | 400x25 | 2608690237 | 9,30 € | |
| PONTEIRO CHATO (Cinzel) (STD) | 400x25 | 2608690125 | 12,90 € | |
| PONTEIRO CHATO (Cinzel) R-TEC Auto Afiável (Retorcido) | 400x25 | 2608690166 | 16,80 € | |
| PONTEIRO CHATO (Cinzel) (STD) | 600x25 | 2608690126 | 25,72 € | |
| PÁ (STD) | 400x50 | 2608587184 | 29,29 € | |
| PÁ (Auto-Afiável) | 400x50 | 2608690097 | 43,29 € | |
| PÁ | 300x80 | 1618601008 | 47,94 € | |
| PÁ | 350x115 | 1618601007 | 85,30 € | |
| CINZEL P/ ASFALTO | 400x90 | 2608690003 | 122,53 € | |
| Cinzel Dentado | 300x32 | 1618601302 | 54,49 € | |

ACESSÓRIOS PARA REBARBADORAS, POLIDORAS E MARTELOS

PONTEIRO ENCABADOURO SEXTAVADO 30

KH4

| TIPO | MEDIDA (mm) | REF. | PREÇO |
|-----------------------------|-------------|------------|-----------------|
| PONTEIRO BICO SEXTAVADO 30 | 400 | 2608690111 | 58,77 € |
| PONTEIRO CHATO SEXTAVADO 30 | 400x35 | 2608690112 | 54,72 € |
| PÁ SEXTAVADA 30 | 450x75 | 2608690113 | 113,02 € |
| PÁ SEXTAVADA 30 (P/ASFALTO) | 450x125 | 2608690114 | 226,03 € |



ADAPTADORES SDS

KH4



1618598159
ENCABADOURO SDS MAX PARA SDS-PLUS
98,73 €



1618598124
ENCABADOURO MONOBLOCO PARA SDS-PLUS
116,55 €

ACESSÓRIOS PARA REBARBADORAS E MARTELOS



DISCO BORRACHA HF

- 2608601005** Flexível, Ø115mm **12,10 €**
- 1608601033** Flexível, Ø125mm **12,51 €**
- 2608601209** Flexível, Ø180mm **27,21 €**

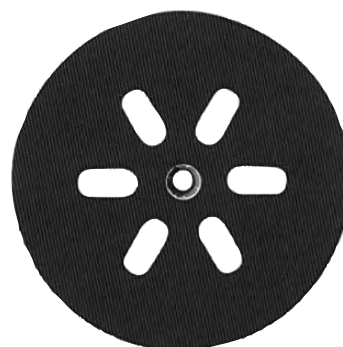

DISCO VELCRO SUPORTE LIXAS HF

- 2608601106** C/ Furos p/ GEX-150 **40,02 €**



DISCO ESPONJA SUPORTE BOINA POLIR HF

- 1608613013** Ø160mm P/ Polidora GPO 12 **60,64 €**



BOINA DE POLIR LÃ DE CORDEIRO Ø170 HF

- 2608612026** **25,21 €**

BOINA DE POLIR PELE CARNEIRO
Ø180mm (33.70) - **7,62 €**



MASSA LUBRIFICANTE P/ MARTELOS HF

- 1605430003** P/ ENGRENAGENS DE REBARBADORAS 225ml **40,02 €**



MASSA DE MANUTENÇÃO P/ MARTELOS HF

- 2608002021** 100ml - Melhora a vida útil do porta ferramentas das brocas e dos cinzeis (PACK 8) **11,08 €**

ACESSÓRIOS PARA REBARBADORAS E BERBEQUINS



BOSCH



BUCHA c/CHAVE p/PERCUSSÃO

2607000982

26,80 €

13mm - Rosca 1/2"x20
c/ ADAPTADOR SDS-Plus



PORCA DE APERTO RÁPIDO

1603340031

24,00 €

Porca Aperto Rápido P/ Discos
SDS - Click M14
P/ todas as rebarbadoras c/ veio M14
S/ usar chave

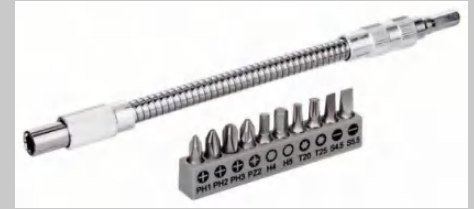

EXTENSÃO METÁLICA FLÉXIVEL

2608522376

11,10 €

200mm C/10 BITS
PH+PZ+HEX+TX+FD



SET 11 SERRAS COROA HCS

2607019450

18,54 €

- 8 serras copo
(22/25/29/35/38/44/51/68mm)
- Adaptador KW 8 + Adaptador
KW 1/4"
- Chave Allen



SERRA CRANEANA MULTIPLA

2608584063

41,26 €

(46-53-60-67-74-81mm)



CONJUNTO 43 BITS 1/4"

2607017164

35,06 €

Conjunto C/43 Bits 1/4: PH1, PH2 (2x), PH3,
PZ1, PZ2 (2x), PZ3, SL3, SL4, SL5, SL6, H3,
H4, H5, H6, T10, T15, T20 (2x), T25, T27, T30,
T40, TH10, TH15, TH20 (2x), TH25, TH27, TH30,
TH40, PH2, PZ2, SL6, T15, T20, T25, chave de
caixa com ímã permanente para parafusos
sextavados de 6 mm, 8 mm e 10 mm



CONJUNTO 32 BITS 1/4"

2607017319

14,90 €

PH+PZ+FEND+SEXT+TORX+RTORX
C/Porta Bits Magnético



CONJUNTO C/ 35 PEÇAS

2608577148

68,24 €

IMPACT METAL HSS

P/Aparafusadoras de impacto
19 Bits 25mm (PH1-PH2-PH3-PZ2-PZ3-
TX15-TX20-TX25-TX30-TX40) + 6 Bits 50mm
(PH2-PZ2-TX15-TX20-TX30-TX40) + 8 Brocas
HSS 2-3-4-5-6-7-8-10 + adaptador
rápido



CONJUNTO C/ 36 PEÇAS

2608522365

55,64 €

IMPACT PT SEXT 1/4

PH2 (2x) / PZ2 (2x) / T20, T25, T30 / PH1 / PH1,
PH2 (3x), PH3 / PZ2 (2x), PZ3 / T15, T20 (2x), T25
(2x), T30 (2x), T40 / PH1-PH2 / PH2-PH3 / PH-
2-PZ2 (2x) / SL1x5,5 / T15-T20 (2x) / T25-T30 /
Chaves sextavadas 8,0/10,0/13,0mm / Suporte
universal Libertação rápida / Suporte universal
magnético standard



CONJUNTO C/ 43 BIT'S 1/4" +PORTA BITS+PUNHO

(2607017692) 2607017693

34,70 €

PH1; PH2 (2x); PH3; PZ1; PZ2 (2x); PZ3; SL3;
SL4; SL5; SL6 (2x); H3; H4; H5; H6; T10; T15
(2x); T20 (2x); T25 (2x); T27; T30; T40; TH10;
TH15; TH20; TH25; TH27; TH30; TH40

Chaves de caixa 6/8/10+ 32 bits L=25 + 8Bits
L=60 +3 Chaves de caixa + Porta bits + Punho

PACK 5 UNI = 30,60/uni



CONJUNTO 7 BROCAS P/ MADEIRA

2607017034

9,38 €

3-4-5-6-7-8-10mm



7 BROCAS HSS P/ AÇO

2607019673

14,30 €

2-3-4-5-6-7-8mm



CONJ. 5 BROCAS SDS-PLUS 5X

2608833910

22,14 €

5-6-6-8-10mm



CONJ. 5 BROCAS EXPERT SDS-PLUS 7X

2608900197

31,28 €

5-6-6-8-10mm

Mala c/ 73 Peças - DIY Starter Box



N/Cód: 285052520

Mala Plástica c/ Bandeja
Dimensões: 320x160x140mm

2607011660

Composição:

- 1 Martelo de Carpinteiro
- 1 Alicate Universal
- 1 Chave Porta Bit's de Punho
- 1 Fita Métrica 3m
- 1 Faca Alcatifa (X-Acto)
- 15 Bit's
- 1 Porta Bit's Magnético
- 1 Ponta Escareadora
- 15 Brocas (p/ Pedra-Aço-Madeira)
- 36 Buchas Nylon+Parafusos

35,56 €

FACA ALCATIFA (X-ACTO)

Lâmina 18mm



1600A01TH6

7,50 €



PORTA FERRAMENTAS
MULTIPLA DE CINTO

1619EC9100

20,00 €



SISTEMA ARMAZENAGEM
MOBILITY SYSTEM

1600A016NA

L-BOXX 102 + Conjunto 13 Divisórias
442 x 357 x 117 mm

76,00 € **EC6**



L-BOXX 136

1600A012G0

L-BOXX 136
442x151x357 mm

41,00 € **EC6**



SISTEMA ASPIRAÇÃO PÓ
(P/MARTELOS)

1600A001G7
GDE 68

47,00 €

EC6





200 DISCOS X-LOCK CORTE INOX 115x1

GWS 880-115
Potência: 880W
Disco: 115mm
PVP = 72€

185 €
LOTE BOSCH 6093



150 DISCOS X-LOCK CORTE INOX 125x1

GWS 880-125
Potência: 880W
Disco: 125mm
PVP = 77€

206 €
LOTE BOSCH 6236



10 DISCOS DIAMANTE BOSCH 230
(universal STD segmentado 2608615065)

10 DISCOS DIAMANTE BOSCH 115
(universal STD X-LOCK segmentado 2608615057)

STD X-LOCK SEGMENTADO 115
GWS 7-115
Potência: 720W
Disco: 115
PVP = 64€

310 €
LOTE BOSCH 6525



NA COMPRA DE 300 DISCOS LAMELADOS P/ INOX Ø115

“BEST for METAL” (P40 - P60 - P80)
PVP = 1,83€

SAI CADA DISCO A 1,47€

Poupança de +/- 20%
Nota: Discos debitados a 1,44€ e rebarbadora a 77€.

1 REBARBADORA PROFISSIONAL BOSCH
GWS 880-125
Potência: 880W
ØDisco: 125 mm
PVP = 77€

518 €



**CAIXA - DISPLAY
COM 10 DISCOS STD
SEGMENTADOS 230**



17,20 € /UNI

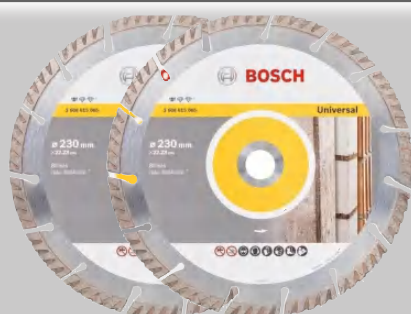

2x STD SEGMENTADO 230

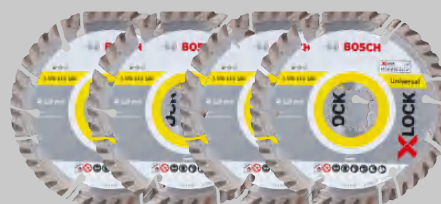

4x STD X-LOCK SEGMENTADO 115

**DISCOS DIAMANTADOS
UNIVERSAL STD (2 UNI 230 + 4 UNI 115)**

61,90 €

LOTE BOSCH 6386



DISCO P/ MADEIRA
160x20-Z=42 dentes
(2608640732)
PVP=42,02€



DISCO MULTIMATERIAL
160x20-Z=48 dentes
(2608640503)
PVP=54,51€

**POUPANÇA
13,30€**

PACK 2

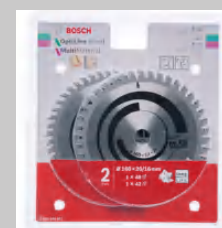

2608644653

59,00 €



DISCO P/ MADEIRA
190x20-Z=48 dentes
(2608640617)
PVP=39,75€



DISCO MULTIMATERIAL
190x20-Z=54 dentes
(2608640509)
PVP=64,73€

**POUPANÇA
13,30€**

PACK 2



2608644655

65,00 €



Rebarbadora
GWS 7-115
720W - Ø115mm

147 €

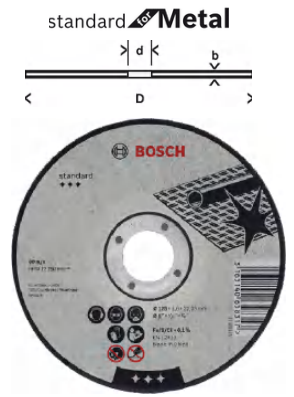

200 Discos Standart
for metal 115x1.0
LOTE BOSCH 6291



Rebarbadora
880-125
880W - Ø125mm

164 €

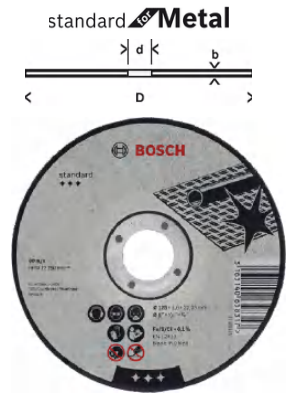

200 Discos Standart
for metal 125x1.0
LOTE BOSCH 6292



Rebarbadora
GWS 2200 J
2.200W - Ø230mm

252 €

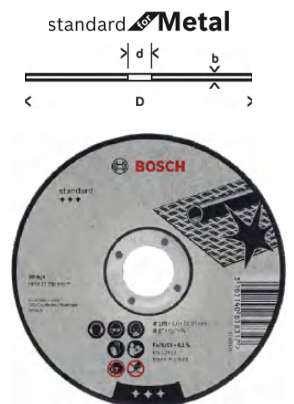

100 Discos Standart for
metal 230x1.9
LOTE BOSCH 6294



BOSCH

APARAFUSAR, LIXAR E ASPIRAR SEM ESFORÇO E LIVRE DE PÓ.

Nova gama de ferramentas Bosch Professional para trabalhar em gesso cartonado.

Bosch Professional



Lixadora de parede e teto GTR 55-225 Professional
550 W. Cabeça e mangueira de pó flexíveis. Extensível.

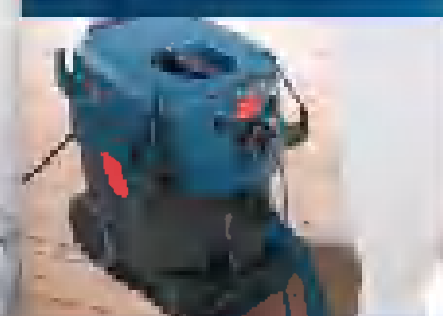

Aspirador GAS 35 M AFC Professional
Filtro classe M. para seco e húmido. Limpeza do filtro automático. Ideal para combinar com a lixadora para um trabalho livre de pó.



Aparafusadora para gesso cartonado a bateria GTB 18V-45 Professional
Motor BRUSHLESS. Batente de profundidade retráctil PowerSAVE. Compacta e ligeira.

Reservado o direito de introduzir modificações sem aviso prévio.
Preços válidos salvo erro tipográfico ou omissão